



*An Online CPD Course
brought to you by
CEDengineering.ca*

Overview of Fire Alarm and Detection Systems

Course No: E04-021
Credit: 4 PDH

A. Bhatia



Continuing Education and Development, Inc.

P: (877) 322-5800
info@cedengineering.ca

Overview of Fire Alarm & Detection Systems

In order to undertake the process of designing a fire system for a building it is necessary to have a sound understanding of the relevant design standards, the legal framework surrounding building safety legislation and a sound working knowledge of product application theory. The following system design process is intended to give a reasonable overview of all the areas of knowledge required for the successful design of a fire alarm system. Due to the complex nature of legislation and design standards relating to fire alarm system design, this course is not intended to be a comprehensive to all aspects of fire alarm design but rather a very useful source of background information to which further application specific detailed information can be added from other sources as required.

Why have a fire alarm system?

The answer to this question depends on the premises in question and the legal requirements. Your local fire marshal may require a fire alarm system based upon the occupancy of the building. Generally the legal requirement for a fire alarm system relates to the protection of life. In general fire alarm systems are installed to:

1. To provide for the safety of occupants in buildings, and to make provision for their evacuation or refuge during a fire or other emergency,
2. To provide fire department with early notification of a fire in a building and to direct them to the area of risk,
3. To reduce loss of property; the property may have considerable intrinsic value and the insurers either require a fire detection system or may incentives its use,
4. To reduce building damage; the building may be unoccupied for periods where equipment is still powered and the owner wishes to ensure that if anything goes wrong the fire department is called to the scene in a timely manner. Sometimes fire detection and alarm systems are used to compensate for structural fire protection shortcomings or to give special cover for items of high value,
5. To reduce the amount of business lost, and
6. Minimize risk to the public who attend unfamiliar properties. It is often a mandatory requirement by the Building Codes.

Whatever the reason, an automatic fire detection and alarm system generally provides a network of manual call points, heat and smoke detectors, and alarm warning devices over the area covered. Once activated, the devices send signals to the fire alarm panel which in turn activates audio and visual devices including lights and sounders. The system may also send its signal to an off site monitoring station.

RISK ASSESSMENT

The first step in the design process is the risk assessment. It underpins the whole system strategy and therefore could be argued as being the most important stage. Risk assessment is the process of considering each part of a building from the point of view of what fire hazards exist within an area and what would happen in the event of fire or if explosion were to occur. This would normally be done when considering the building from the point of view of general safety. Clearly very small premises only require a first level of fire protection, such as safe construction, clear escape routes and a fire extinguisher. Equally obviously, large hotels will require a fully automatic fire detection and alarm system, multiple sets fire protection equipment and adequate emergency lighting and escape signage. The Risk Assessment process is to help building owners of buildings between these two extremes make adequate and appropriate provision. Building owners or operators will often want to employ the services of a professional risk assessor to ensure that the building is considered impartially and in adequate detail. However there are checklists and technical advice available so that the task can be done 'in-house'.

CONSULT WITH ALL INTERESTED PARTIES

Before embarking on a detailed design, it is highly recommended as a minimum to consult the following agencies so as to ensure that the fire detection and alarm system meets the requirements of all concerned including:

1. The authority responsible for enforcing health and safety legislation,
2. The property insurer,
3. The building user (where appropriate),
4. The proposed installer, and
5. Fire engineering specialists (where appropriate)

DESIGN PROCESS

A fire alarm system should be designed to provide early detection and warning of a fire. The designer must consider the size, complexity and use of the building, and the degree of detection and warning desired. While the design of fire alarm systems is normally regulated by building codes, the level of protection specified is usually a minimum and the designer should consider providing higher levels of protection where circumstances indicate the need. Before looking at the details of the alarm system, it is necessary to understand some of the concepts that are used to assist the system designer. Buildings are divided up into sections in three ways as far as fire safety engineering is concerned: fire compartments, detection zones and alarm zones.

Review of the Building

1. Review the physical properties of the building such as:
 - Building height
 - Number of floors
 - Area of each floor
 - Smoke compartments
 - Sprinkler system, if any
2. What fire alarm equipment is required in this occupancy
3. What locations are fire alarm devices required
4. Determine if there is a special use or occupancy (refer to Model Building Code - Chapter 4, and Life Safety Code - Chapter 11)

Fire Compartments

A fire compartment is a part of a building that is separated from the rest of the building by a fire resistant structure so as to limit the spread of fire within the building. The requirements for designing a building and hence its fire compartments, are defined in building regulations. It is necessary, however, for the designer of fire detection and alarm system to be familiar with the design of the building, in particular the position and extent of its fire compartments.

Detection Zones

Fire detection zones are essentially a convenient way of dividing up a building to assist in quickly locating the position of a fire. The zone boundaries are not physical features of the building, although it is normal to make the zone boundary coincide with walls, floors and specifically fire compartments. The size and position of the detection zones will therefore tend to be dependant on the shape of the buildings, but will also depend on what the building is used for and to some extent the number of people the building is expected to contain at any one time. Some specific recommendations with respect to detection zones are:

1. Zones should be restricted to single floors, except where the total floor area of a building is less than 3000 ft².
2. Voids above or below the floor area of a room may be included in the same zone as the room so long as they are both in the same fire compartment.
3. Zones should not be larger than 20,000 ft² except for manual systems in single storey open plan buildings, such as a warehouse, where up to 100,000 ft² is allowed.
4. Fire detectors in an enclosed stairwell, lift shaft or the like should be considered as a separate zone.
5. The search distance within a zone should be less than 300 ft in any direction (all possible entrance points must be considered). This can be relaxed when using addressable systems, if the information provided at the control and indicator equipment would allow fire fighters, unfamiliar with the building, to proceed directly to the location of the fire. The search distance only relates to the distance from entering a zone to being able to determine the location of the fire, it is not necessary to travel to the fire.
6. Zones should not cross fire compartments, *a fire compartment can contain several zones but a zone should not contain more than one fire compartment.*

Alarm Zones

Alarm zones are only needed in buildings where operation of the alarms needs to be different in certain parts of the buildings. If the only requirement is to activate all the

alarm sounders to provide a single common evacuate signal once a fire is detected, then alarm zones are not needed as the whole building is considered one alarm zone.

For more complex buildings where it is necessary to operate alarm devices differently in parts of the building, then the building should be divided into alarm zones such that all of the alarm devices in one alarm zone operate in the same way. Here are some recommendations for alarm zones:

1. The boundaries of all alarm zones should comprise fire-resisting construction.
2. Signal overlap between alarm zones should not cause confusion.
3. The same alarm and alert signals should be used throughout a building.
4. A detection zone must not contain multiple alarm zones, alarm and detection zone boundaries should coincide. An alarm zone may contain multiple detection zones.

Once the building zones and fire alarm requirements are determined, install per the applicable standards.

RELEVANT STANDARDS

The design, installation and testing of the fire detection and alarm system shall comply with all state and local codes with no exception. Standards produced by agencies such as Underwriters Laboratories (UL) and/or Approved by Factory Mutual (FM) and National Fire Protection Association (NFPA) are generally endorsed by relevant building codes. Often these standards are called up within guidance documents for pieces of legislation and since they represent best current practice, can be generally be used by building owners to demonstrate that equipment they have installed is adequate and appropriate. Fire alarm system requirements are found in:

- NFPA 72, National Fire Alarm Code
- NFPA 101, Life Safety Code
- Model Building Codes

NFPA 72 was written to provide requirements for the installation, performance, testing, inspection, and maintenance of the fire alarm system. If you want to know if a fire alarm system is required for a given occupancy, then NFPA 101, Life Safety Code and other related codes (building codes) make that determination.

The following organizations issue guidelines and standards that relate to the USA; other countries will have their own standards.

NFPA Codes and Standards

NFPA publishes standards for the proper application, installation, and maintenance of automatic smoke detectors. The principal codes which should be reviewed before specifying or installing automatic smoke detectors are listed below:

NFPA publishes codes and standards concerning all phases of fire protection. Among those which directly concern automatic smoke detectors are:

1. NFPA 70 National Electrical Code:

- Article 210, Branch Circuits
- Article 760, Fire Protective Signaling Systems
- Article 500, Hazardous Areas

2. NFPA 72 National Fire Alarm Code:

NFPA 72 covers minimum performance, location, mounting, testing, and maintenance requirements of automatic fire detectors.

3. NFPA 90A Standard for the Installation of Air Conditioning and Ventilating Systems

4. NFPA 92A Smoke Control Systems in Malls, Atria, and Large Areas

NFPA 90A and 92A provide information on the use of smoke detectors in ducts of HVAC systems and smoke control systems.

5. NFPA 101 Life Safety Code

NFPA 101 specifies the requirements for smoke detection in both new and existing buildings depending on the type of occupancy.

Building and Fire Codes

There are three independent regional organizations which write model building and fire codes which become law when adopted by local and state governments. These codes specify smoke detector requirements based on building type and occupancy. The organizations are:

1. Building Officials and Code Administrators (BOCA) - BOCA's National Building Code is generally used throughout the Northeast and Midwest regions of the United States.
2. International Conference of Building Officials (ICBO) - ICBO's Uniform Building Code is generally used throughout the West and Southwest regions of the United States.
3. Southern Building Code Congress International (SBCCI) - SBCCI's Standard Building Code is generally used in the South and Southeast regions of the United States.

In addition these above listed organizations have formed an umbrella organization known as the International Code Council (ICC), for the purpose of combining the codes produced by the above three organizations into a single set of model building and fire codes.

Testing Laboratories

Testing laboratories test detectors, control panels and other components of fire alarm systems to verify conformance with NFPA requirements and their own standards. Equipment that passes their tests are identified by a label.

Underwriters Laboratories, Inc. (UL) - UL publishes an annual report listing fire protection equipment which bear the UL label. Its standards which apply to smoke detectors are:

- UL 38 Manually Actuated Signaling Boxes
- UL 217 Single and Multiple Station Smoke Detectors
- UL 228 Door Closers-Holders for Fire Protective Signaling Systems
- UL 268 Smoke Detectors for Fire Protection Signaling Systems
- UL 268A Smoke Detectors for Duct Applications
- UL 346 Water flow Indicators for Fire Protective Signaling Systems
- UL 521 Heat Detectors for Fire Protective Signaling Systems
- UL 464 Audible Signaling Applications
- UL 864 Standards for Control Units for Fire Protective Signaling Systems

- UL 1481 Power supplies for Fire Protective Signaling Systems
- UL 1638 Visual Signaling Appliances
- UL 1971 Signaling devices for the hearing impaired

Factory Mutual Research (FM) - FM publishes an annual report listing fire protection equipment which bears its label.

- Factory Mutual Loss Prevention Data Sheets, as appropriate for the hazard
- Factory Mutual Loss Prevention Data Sheet 5-40 Protective Signaling Systems
- Factory Mutual Loss Prevention Data Sheet 5-43 Auxiliary Protective Signaling Systems

There are other testing laboratories listed here that may provide similar services:

- Industry Publications NEMA Guide for Proper Use of Smoke Detectors in Duct Applications
- NEMA Training Manual on Fire Alarm Systems
- NEMA Guide to Code Requirements for Fire Protective Signaling and Detection Systems
- NEMA Guide for proper Use of System Smoke Detectors

The final system shall receive an Underwriters Laboratories Field Certification from an alarm service company authorized to issue Underwriters Laboratories certificates. Note that there are other standards that relate to specific applications (such as hospitals or data processing installations).

FIRE ALARM COMPONENTS

A typical fire alarm system consists of a control unit, manually activated signaling boxes (pull boxes), fire detectors and audible alarm devices. There may also be visual signal devices to warn the hearing-impaired, annunciators to indicate the origin of the alarm signal, and emergency telephones and other equipment for communication between the central control panel and other parts of the building (refer to the figure below).

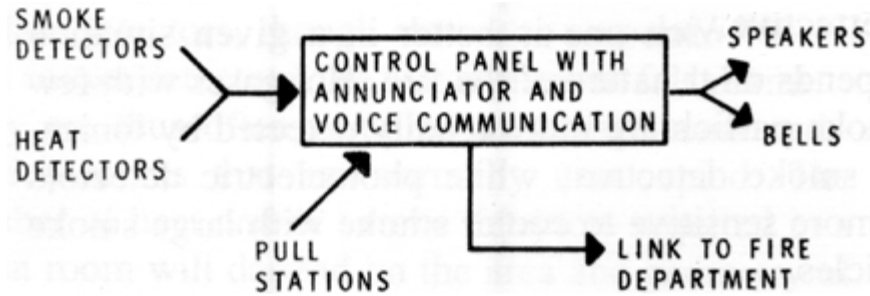

Figure - A basic fire alarm system

The control unit powers the fire alarm system. It transmits signals from pull boxes and fire detectors to the alarm signal devices, either audible or visual, installed at strategic locations in the building. Audible signal devices include bells, speakers, and sirens, a strobe light being a common visual signal device.

FIRE ALARM CONTROL PANEL (FACP)

The control panel is the "brain" of the fire detection and alarm system. It is responsible for monitoring the various alarm "input" devices such as manual and automatic detection components, and then activating alarm "output" devices such as horns, bells, warning lights, emergency telephone dialers, and building controls. Control panels may range from simple units with a single input and output zone, to complex computer driven systems that monitor several buildings over an entire facility. There are two main control panel arrangements, conventional and addressable, which are discussed below.

- 1) **Conventional or "point wired" fire detection and alarm systems** - In a conventional system one or more circuits are routed through the protected space or building. Along each circuit, one or more detection devices are placed. Selection and placement of these detectors is dependent upon a variety of factors including the need for automatic or manual initiation, ambient temperature and environmental conditions, the anticipated type of fire, and the desired speed of response. One or more device types are commonly located along a circuit to address a variety of needs and concerns.

Upon fire occurrence, one or more detectors will operate. This action closes the circuit, which the fire control panel recognizes as an emergency condition. The panel will then activate one or more signaling circuits to sound building alarms and

summon emergency help. The panel may also send the signal to another alarm panel so that it can be monitored from a remote point.

In order to ensure that the system is functioning properly, these systems monitor the condition of each circuit by sending a small current through the wires. Should a fault occur, such as due to a wiring break, this current cannot proceed and is registered as a "trouble" condition. The indication is a need for service somewhere along the respective circuit.

In a conventional alarm system, all alarm initiating and signaling is accomplished by the system's hardware which includes multiple sets of wire, various closing and opening relays, and assorted diodes. Because of this arrangement, these systems are actually monitoring and controlling circuits, and not individual devices.

To further explain this, assume that a building's fire alarm system has 5 circuits, zones A through E, and that each circuit has 10 smoke detectors and 2 manual stations located in various rooms of each zone. A fire ignition in one of the rooms monitored by zone "A" causes a smoke detector to go into alarm. This will be reported by the fire alarm control panel as a fire in circuit or zone "A". *It will not indicate the specific detector type or location within this zone.* Emergency responding personnel may need to search the entire zone to determine where the device is reporting a fire. Where zones have several rooms, or concealed spaces, this response can be time consuming and wasteful of valuable response opportunity.

The advantage of conventional systems is that they are relatively simple for small to intermediate size buildings. Servicing does not require a large amount of specialized training.

Disadvantages of conventional systems

- Conventional systems can be expensive to install because of the extensive amounts of wire that are necessary to accurately monitor initiating devices. Conventional systems may also be inherently labor intensive and expensive to maintain.
- Each detection device may require some form of operational test to verify it is in working condition. Smoke detectors must be periodically removed, cleaned, and recalibrated to prevent improper operation.

- With a conventional system, there is no accurate way of determining which detectors are in need of servicing. Consequently, each detector must be removed and serviced, which can be a time consuming, labor intensive, and costly endeavor.
 - If a fault occurs, the "trouble" indication only states that the circuit has failed, but does not specifically state where the problem is occurring. Subsequently, technicians must survey the entire circuit to identify the problem.
- 2) **Addressable or "intelligent" systems** represent the current state-of-the-art in fire detection and alarm technology. Unlike conventional alarm methods, these systems monitor and control the capabilities of each alarm initiating and signaling device through microprocessors and system software. In effect, each intelligent fire alarm system is a small computer overseeing and operating a series of input and output devices.

Like a conventional system, the address system consists of one or more circuits that radiate throughout the space or building. Also, like standard systems, one or more alarm initiating devices may be located along these circuits. The major difference between system types involves the way in which each device is monitored. In an addressable system, each initiating device (automatic detector, manual station, sprinkler water flow switch, etc.) is given a specific identification or "address". This address is correspondingly programmed into the control panel's memory with information such as the type of device, its location, and specific response details such as which alarm devices are to be activated.

The control panel's microprocessor sends a constant interrogation signal over each circuit, in which each initiating device is contacted to inquire its status (normal or emergency). This active monitoring process occurs in rapid succession, providing system updates every 5 to 10 seconds.

The addressable system also monitors the condition of each circuit, identifying any faults which may occur. One of the advancements offered by these systems is their ability to specifically identify where a fault has developed. Therefore, instead of merely showing a fault along a wire, they will indicate the location of the problem. This permits faster diagnosis of the trouble, and allows a quicker repair and return to normal.

Each device, for purpose of testing and future reference shall have the map number identified on the device and temporary protective cover that corresponds with the address on the hard copy provided by the electrical contractor. The address for each device shall be programmed as follows: a) Building, b) Floor, c) Room/Corridor, d) additional information

Advantages provided by addressable alarm systems

- **Stability** - stability is achieved by the system software. If a detector recognizes a condition which could be indicative of a fire, the control panel will first attempt a quick reset. For most spurious situations such as insects, dust, or breezes, the incident will often remedy itself during this reset procedure, thereby reducing the probability of false alarm. If a genuine smoke or fire condition exists, the detector will reenter the alarm mode immediately after the reset attempt. The control panel will now regard this as a fire condition, and will enter its alarm mode.
- **Enhanced Maintenance** - With respect to maintenance, these systems offer several key advantages over conventional ones. First of all, they are able to monitor the status of each detector. As a detector becomes dirty, the microprocessor recognizes a decreased capability, and provides a maintenance alert. Advanced systems, incorporate another maintenance feature known as drift compensation. This software procedure adjusts the detector's sensitivity to compensate for minor dust conditions. This avoids the ultra sensitive or "hot" detector condition which often results as debris obscures the detector's optics. When the detector has been compensated to its limit, the control panel alerts maintenance personnel so that servicing can be performed.
- **Ease of Modification** - Modifying these systems, such as to add or delete a detector, involves connecting or removing the respective device from the addressable circuit, and changing the appropriate memory section. This memory change is accomplished either at the panel or on a personal computer, with the information downloaded into the panel's microprocessor.

The main disadvantage of addressable systems is that each system has its own unique operating characteristics. Therefore, service technicians must be trained for the respective system. Periodic update training may be necessary as new service methods are developed.

INITIATING DEVICES

Smoke Detectors

As the name implies, these devices are designed to identify a fire while in its smoldering or early flame stages. Smoke detectors operate on either an ionization or photoelectric principle, with each type having advantages in different applications.

Photoelectric Detectors: Photoelectric smoke detectors use light and how it is reflected to detect smoke. Normally light is projected into a smoke sensing chamber inside the detector assembly. The light hits a black background of the chamber and is absorbed. When enough smoke enters the chamber it reflects the light on to a sensor inside the chamber. This causes the sensor to indicate an alarm. Photoelectric detectors are suitable for most applications giving the fastest response to slow burning fires - the most common start to fire events. Use of photoelectric detectors is highly recommended to provide coverage for escape routes due to their superior ability to detect optically dense smoke that would easily obstruct the use of escape routes.

Ionization Detectors: Ionization detectors were the first type of detector to be commercially developed and are also a popular choice. These generally contain two chambers. One is used as a reference to compensate for changes in ambient temperature, humidity or pressure. The second contains a radioactive source, usually alpha particle, which ionizes the air passing through the chamber where a current flows between two electrodes. Even when invisible smoke enters the chamber, it disrupts the flow of current and generates an alarm.

Ionization detectors have superior response to fast burning fires but an inferior response to slow smoldering fires, which are typical with modern construction materials. Ionization detectors are also less acceptable from an environmental point of view due to the radioactive material that they contain. There is increasing restriction on the transportation and disposal of ionization detectors so it is recommended that alternative types are used where possible.

Considerations in Selecting Smoke Detectors

The characteristics of an ionization detector make it more suitable for detection of fast flaming fires that are characterized by combustion particles in the 0.01 to 0.3 micron size range. Ionization smoke detectors are sensitive to the presence of ions, which are

electrically charged particles produced by the chemical reactions that take place during combustion.

Photoelectric smoke detectors are better suited to detect slow smoldering fires that are characterized by particulates in the 0.3 to 10.0 micron size range. Photoelectric detectors react to visible particles of smoke.

Each type of detector can detect both types of fires, but their respective response times will vary, depending on the type of fire.

Because the protected buildings normally contain a variety of combustibles, it is often very difficult to predict what size particulate matter will be produced by a developing fire. The fact that different ignition sources can have different effects on a given combustible further complicates the selection. A lighted cigarette, for example, will usually produce a slow smoldering fire if it is dropped on a sofa or bed. However, if the cigarette happens to fall upon a newspaper on top of a sofa or bed, the resulting fire may be characterized more by flames than by smoldering smoke.

The innumerable combustion profiles possible with various fire loads and possible ignition sources make it difficult to select the type of detector best suited for a particular application.

For more information, see NFPA 72-1996, paragraphs A-5-3.6.1.2, and tables A-5-3.6.1.1, A-5-3.6.1.2(a), and A-5-3.6.1.2(b).

Self Contained Smoke Detectors/Alarms

Some smoke detectors are self contained with a sensor to sense the smoke and a very loud electronic horn to wake people up. These are commonly used in apartment suites and houses that are technically referred to as smoke alarms. Smoke alarms have a built-in audible alarm device in addition to a smoke sensor, and are intended to warn only the occupants in the room or suite in which they are located. Smoke detectors on the other hand are connected to the building fire alarm system and are designed to initiate an alarm signal to warn the occupants of the entire building.

Self contained smoke detector/alarm can run off of a 9-volt battery or 120-volt house current. Some models run off of house current and change to battery backup if the power fails. NFPA 72 requirements dictate that alarm notification appliances (including

smoke detectors with built in sounders) produce the 3-pulse temporal pattern fire alarm evacuation signal described in ANSI S3.41. (Audible Emergency Evacuation Signals)

Smoke Detectors have Limitations

Smoke detectors offer the earliest possible warning of fire. Nevertheless, smoke detectors do have limitations.

They may not provide early warning of a fire developing on another level of a building. A first floor detector, for example, may not detect a second floor fire. For this reason, detectors should be located on every level of a building.

In addition, detectors may not sense a fire developing on the other side of a closed door. In areas where doors are usually closed, detectors should be located on both sides of the door.

As already indicated, detectors have sensing limitations. Ionization detectors are better at detecting fast, flaming fires than slow, and smoldering fires. Photoelectric smoke detectors sense smoldering fires better than flaming fires. Because fires develop in different ways, and are often unpredictable in their growth, neither type of detector is always best. In addition, a given detector may not always provide significant advance warning of fires when fire protection practices are inadequate, or when caused by violent explosions, escaping gas, improper storage of flammable liquids such as cleaning solvents, etc.

Heat Detectors

Heat detectors warn of fire when the temperature in the area around the smoke detector reaches a certain level. The static response temperature of a heat detector should be a minimum of 29°C above the maximum ambient temperature likely to be experienced for long periods of time and 4°C above the maximum temperature likely to be experienced for short periods of time.

Heat detectors are highly reliable and have good resistance to operation from non-hostile sources. They are also very easy and inexpensive to maintain. On the down side, heat detectors do not notice smoke. They do not function until room temperatures have reached a substantial temperature, at which point the fire is well underway and damage is growing exponentially. Subsequently, thermal detectors are usually not permitted in life safety applications. They are also not recommended in locations where there is a

desire to identify a fire before substantial flames occur, such as spaces where high value thermal sensitive contents are housed. However, a heat detector could be valuable additional protection in areas such as kitchens and attics, where smoke detectors are not recommended. They are not recommended for the use in bedrooms or sleeping areas. There are several types of heat detectors including:

Fixed-temperature heat detectors: Fixed temperature heat detectors operate when the sensing mechanism reaches its specific temperature threshold. Usually there is a fusible metal element which melts and causes a short on the initiating circuit.

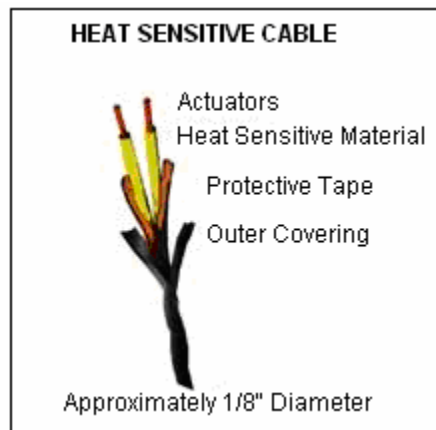

The most common units are fixed temperature devices that operate when the room reaches a predetermined temperature (usually in the 135°-165°F/57°-74°C). Normally fixed temperature detectors employ a fusible alloy element which must be replaced after the detector has operated. Different temperature rated elements are available to take account of varying ambient air temperatures. A typical set temperature might be 57.2°Centigrade. These detectors are *non-restoring type* (because it is destroyed when activated) and have to be replaced, if another setting is required.

When a fixed temperature device operates, the temperature of the surrounding air will always be higher than the operating temperature of the device itself. This difference between the operating temperature of the device and the actual air temperature is commonly spoken of as thermal lag, and is proportional to the rate at which the temperature is rising.

Rate-of-rise (ROR) heat detectors: The second most common type of thermal sensor is the rate-of-rise detector, which identifies an abnormally fast temperature climb over a short time period. Rate of rise detectors also have a fixed temperature backstop to

ensure that even very slow increases in temperature will eventually raise an alarm, if the increase continues for a sufficiently long period. Rate of rise detectors are not usually used for suppression systems because they operate on a 12 to 15°F temperature rise per minute. This makes them too sensitive to sudden environmental changes causing false alarms and unexpected discharges.

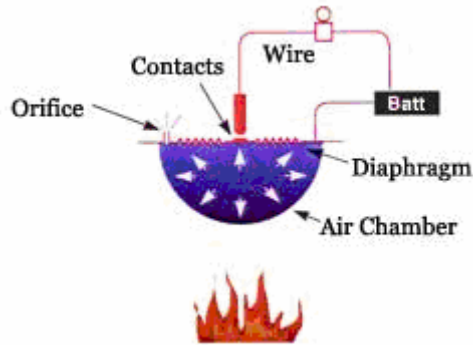

The rate of rise type is the most sensitive type of heat detector, particularly when used in areas where the ambient temperature can reach low levels and therefore create a large difference between the ambient temperature and the trigger temperature of a fixed temperature detector. In order to avoid false alarms, the rate of rise detectors should not be used in areas subject to frequent temperature swings, such as in kitchens, boiler rooms and warehouses with large doors to open air. In most of these detectors, when the rate of rise element alone has been activated, the detector is self-restoring.

Both rate of rise and fixed temperature heat detectors are “spot type” detectors, which mean that they are periodically spaced along a ceiling or high on a wall and are suitable for inclusion in open, closed or line monitored systems.

Rate Compensating Type: Rate compensating heat detectors operate when the surrounding air temperature reaches a specific temperature threshold. As a result the thermal lag associated with fixed temperature detectors is eliminated. Usually there is a hermetically sealed tube with two (2) sensing elements, an outer metal tube and an internal pair of bi-metallic struts which are connected to both ends of the tube. During a slow rise in temperature, the struts and the outer shell expand at the same time until the unit reaches its specific temperature value, and operates. As the temperature rises quickly, the outer shell expands faster than the struts, pulling them closer together, allowing the contacts to close sooner. This compensates for the thermal lag time

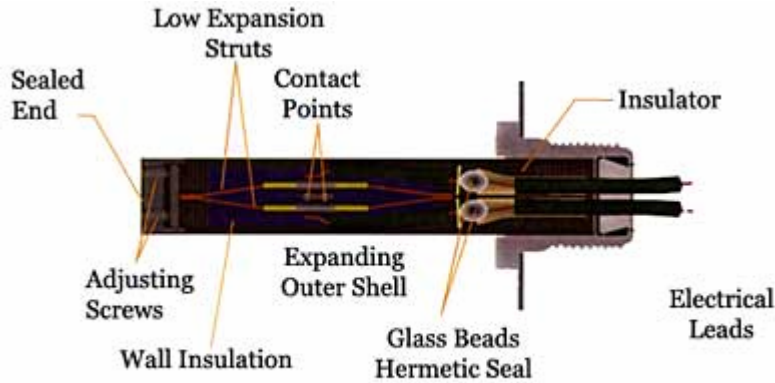

Section of spot type rate compensation detector

Fixed Temperature Line Type Detector: The fourth detector type is the fixed temperature line type detector, which consists of two cables and an insulated sheathing that is designed to breakdown when exposed to heat. These can take the form of a heat sensitive cable which will operate, at a predetermined temperature, as an open circuit device. Melting of the cable insulation provides a short-circuit between conductors. After operation the destroyed length of cable must be replaced. Linear detectors may be used in large areas such as warehouses. Alternative types of linear detector exist including the heat pneumatic operating on the rate of rise principle. *The advantage of line type over spot detection is that thermal sensing density can be increased at lower cost.*

Considerations in Selecting Heat Detectors

Each type of heat detector has its advantages, and one cannot say that one type of heat detector should always be used instead of another. If you were to place a rate-of-rise (ROR) heat detector above a large, closed oven, then every time the door is opened a false alarm could be generated due to the sudden heat transient. In this circumstance the fixed threshold detector would probably be best. If a room is protected with a fixed heat detector filled with highly combustible materials, then a fast flaming fire could exceed the alarm threshold due to thermal lag. In this case the ROR heat detector may be preferred.

A general comparison of smoke v/s heat detectors is as follows:

- 1) A smoke detector transmits a signal to the control unit when the concentration of airborne combustion products reaches a predetermined level. A heat detector transmits a similar signal when the temperature reaches a predetermined level or when there is an abnormal rate of temperature rise.

- 2) The key advantage of smoke detectors is their ability to identify a fire while it is still in its incipient. As such, they provide added opportunity for emergency personnel to respond and control the developing fire before severe damage occurs. Smoke detectors give the earliest warning of fire, typically responding to a fire 1/10th of the size as that required to operate a heat detector.
- 3) Heat detectors are not prone to false alarms although it is rather insensitive to smoldering fires of low temperature. Heat detectors are, therefore, preferred for the environments where the ambient conditions might cause false alarms.
- 4) Heat detectors must be mounted closer together than smoke detectors, so while the mounting bases are compatible for all types, care should be taken to ensure that the spacing between detectors is appropriate for the detector type fitted. With analogue systems it is possible for the photo thermal detector to act as a thermally enhanced smoke detector during certain times and as a pure heat detector at other times. If this mode of operation is envisioned, then spacing must be those appropriate for heat detectors.

Beam Detectors

Beam detectors provide a cost effective method of covering wide open plan areas such as galleries and atria, however care should be taken that activities in the space do not obstruct the beam, and that the building structure is such that the beam does not 'move' or false operation may result. This detector consists of two components, a light transmitter and a receiver, that are mounted at some distance up to 300 ft (100 m) apart. As smoke migrates between the two components, the transmitted light beam becomes obstructed and the receiver is no longer able to see the full beam intensity. This is interpreted as a smoke condition, and the alarm activation signal is transmitted to the fire alarm panel.

If optical beam detectors are mounted within 2 feet (600 mm) of the ceiling level, they should be positioned such that no point in a protected space is more than 25 ft (7.6 m) from the nearest part of the optical beam. Should the beam detector be mounted more than 600 mm below ceiling level, then spacing should be altered to 12.5% of the height of the beam detector above the highest likely seat of any fire.

Other than the part of the beam within 500 mm of the beam's transmitter or receiver, if any other section of a beam which runs closer than 500 mm to any wall partition or other

obstruction to the flow of hot gasses, that section of the beam should be discounted from providing protection.

Where optical beam detectors are mounted in the apex of pitched roofs then the same enhanced spacing can be applied as for point smoke detectors.

The area covered by a single optical beam detector should not exceed that of a single detection zone.

Aspirating Systems (VESDA)

Air aspirating detectors are extremely sensitive and are typically the fastest responding automatic detection method. This type of system aspirates the smoke from various locations into a tube where the smoke is analyzed electro-optically by a line of sight transmitter-receiver set. This device consists of two main components: a control unit that houses the detection chamber, an aspiration fan and operation circuitry; and a network of sampling tubes or pipes. Along the pipes are a series of ports that are designed to permit air to enter the tubes and be transported to the detector. Under normal conditions, the detector constantly draws an air sample into the detection chamber, via the pipe network. The sample is analyzed for the existence of smoke, and then returned to atmosphere. If smoke becomes present in the sample, it is detected and an alarm signal is transmitted to the main fire alarm control panel.

Aspirating systems should be specified where protection is required in areas such as cold stores or areas where a very fast response to fire is needed, and while each sense point can be considered a smoke detector, special training is needed to design such systems as they are normally required to cover special risks. Many high technology organizations, such as telephone companies, have standardized on aspiration systems. In cultural properties they are used for areas such as collections storage vaults and highly valuable rooms. These are also frequently used in aesthetically sensitive applications since components are often easier to conceal, when compared to other detection methods.

Flame Detectors

The Optical detector is an electronic device containing electro-optical sensors that are sensitive to electromagnetic radiation in the UV, VIS, IR spectral bands. The Optical detector "sees" the fire by detecting the electromagnetic radiation emitted by the combustion products. They are line of sight devices that operate on either an

infrared, ultraviolet or combination principle. As radiant energy in the approximate 4,000 to 7,700 angstroms range occurs, as indicative of a flaming condition, their sensing equipment recognizes the fire signature and sends a signal to the fire alarm panel. The advantage of flame detection is that it is extremely reliable in a hostile environment. They are usually used in high value energy and transportation applications where other detectors would be subject to spurious activation. Common uses include locomotive and aircraft maintenance facilities, refineries and fuel loading platforms, and mines. A disadvantage is that they can be very expensive and labor intensive to maintain. Flame detectors must be looking directly at the fire source, unlike thermal and smoke detectors which can identify migrating fire signatures. Their use in cultural properties is extremely limited.

DETECTORS SUB-CLASSIFICATION

To further break down the detector groupings, there are two sub-groups known as "Spot type" and "Line type" initiating devices. The NFPA definitions of Spot and Line type are as follows:

NFPA Preferred Definition of a Line type device - A device in which detection is continuous along a path. Typical examples are rate-of-rise pneumatic tubing detectors, projected beam smoke detectors, and heat sensitive cable.

NFPA Preferred Definition of a Spot type device - A device in which the detecting element is concentrated at a particular location. Typical examples are bimetallic detectors, fusible alloy detectors, certain pneumatic rate-of-rise detectors, certain smoke detectors, and thermoelectric detectors.

A Spot type detector will provide coverage for a limited area, or small spot, while the line sensing type can protect or monitor very large areas, such as large atriums. Spot type detectors have a maximum theoretical rated coverage of 900 sq. ft (30 ft x 30 ft) in large open rooms. If placed in a narrow hallway, the maximum allowed rated coverage might be increased.

The Line type sensors are typically of the "projected beam" or heat sensitive cable variety. In the average residential home, all detectors will most likely be of the Spot type. The maximum theoretical rated coverage area for the projected beam detector can be as large 20,000 sq. ft. *Note: This maximum coverage area for Spot type and Line type detectors is only a general statement, and should not be used in every circumstance.*

POSITIONING OF SMOKE & HEAT DETECTORS

To provide effective early warning of a developing fire situation, smoke detectors should be installed in all areas of the protected premises. Total coverage as defined by NFPA 72 should include all rooms, halls, storage areas, basements, attics, lofts, and spaces above suspended ceilings including plenum areas utilized as part of the HVAC system. In addition, this should include all closets, elevator shafts, enclosed stairways, dumbwaiter shafts, chutes and other subdivisions and accessible spaces.

Fire detection systems installed to meet local codes or ordinances may not be adequate for early warning of fire. Some codes or ordinances have minimum objectives such as capturing elevators or preventing circulation of smoke through the HVAC systems instead of early detection of fire.

A user should weigh the costs against the benefits of installing a complete fire detection system when any detection system is being installed. The location, quantity and zoning of detectors should be determined by what objectives are desired rather than the minimum requirements of any local codes or ordinances. Detectors may be omitted from combustible blind spaces when any of the following conditions prevail:

- 1) Where the ceiling of a concealed space is attached directly to the underside of the supporting beams of a combustible roof or floor deck.
- 2) Where the concealed space is entirely filled with noncombustible insulation. (In solid joisted construction, the insulation need only fill the space from the ceiling to the bottom edge of the joist of the roof or floor deck.)
- 3) Where there are small concealed spaces over rooms, provided the space in question does not exceed 50 square feet (4.6 square meters).

The number of heat and/or smoke detectors required in a given room will depend on the area and geometry of the room and the limitations of the equipment. All smoke detectors have similar spacing requirements; heat detectors also all have similar spacing requirements although these are different to smoke detectors. For general areas the spacing between any point in a protected area and the detector nearest to that point should not exceed 7.5 m for a smoke detector and 5.3 m for a heat detector.

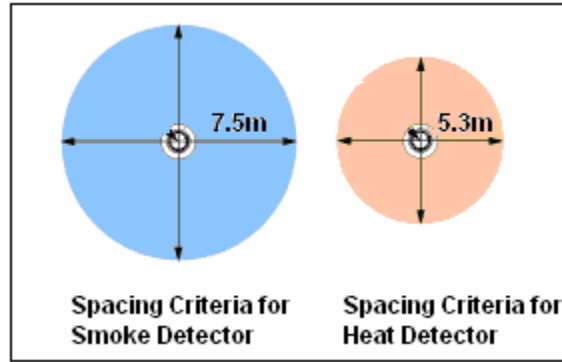

The above are the maximum areas that can be covered by an individual detector. In order to ensure that coverage is provided into the corners of rooms and to ensure that there is no gap at the junction point of multiple detectors, spacings have to be reduced.

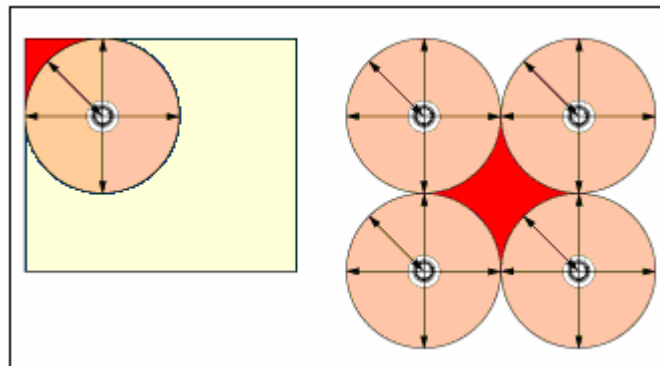

To ensure complete coverage for square layouts, spacings between detectors and walls should be reduced to 5 m for a smoke detector and 3.5 m for a heat detector.

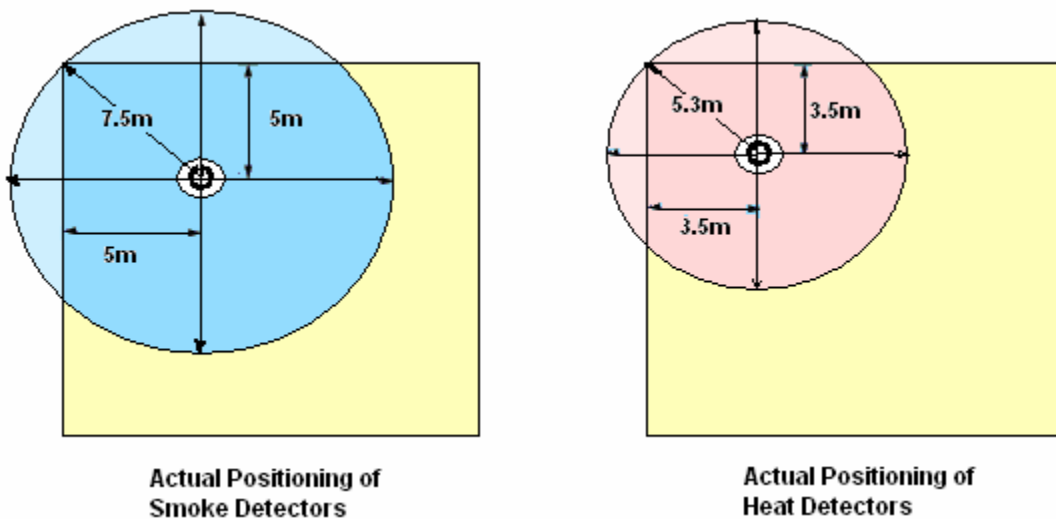

To ensure complete coverage, spacings between detectors should be reduced to 10 m between smoke detectors and 7 m between heat detectors.

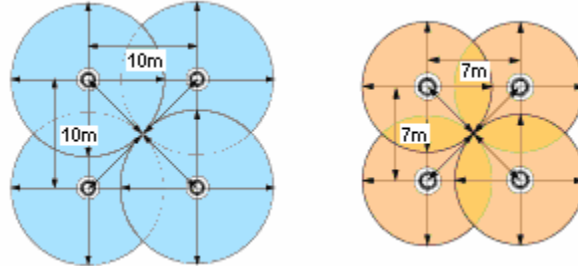

For corridors less than 2 m wide, only the centre line need be considered, therefore it is not necessary to reduce detector spacings in order to provide complete coverage. Therefore for smoke detectors spacing becomes 7.5 m from a wall and 15 m between detectors. For heat detectors, the spacing becomes 5.3 m to a wall and 10.6 m between detectors.

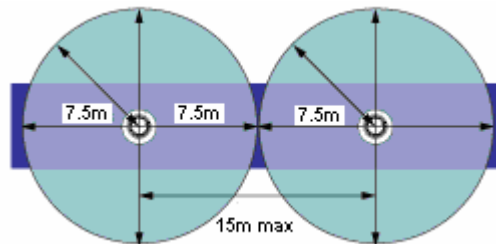

The above data is based on flat level ceilings; for pitched ceilings or ceilings with a non-flat surface, spacings will alter. Where detectors must be mounted onto a pitched ceiling, a detector should be mounted near to the apex but spacing can be increased by 1% for each 1 degree of slope up to 25%. ‘Near’ is defined as within 600 mm for smoke detectors and within 150 mm for heat detectors.

Note that some fire protection codes specify detector spacing on a given center-to-center distance between detectors under ideal conditions. These spacing are based on rooms with smooth ceilings with no physical obstructions between the contents being protected and the detectors. Moreover, they are also based on a maximum ceiling height, and on the assumption that the value and the combustible nature of the contents of the room to be protected do not warrant greater protection or closer spacing.

Mounting Heights of Detectors

Under all normal circumstances point type fire detectors should be mounted on the ceiling. This ensures that the height restrictions are met together with the following table.

| | Ceiling Heights (ft) | |
|------------------------------|----------------------|-------------------------------|
| | General Limits | Rapid Attendance ¹ |
| Heat detectors ² | 7.5 | 12 |
| Point type smoke detectors | 10.5 | 15 |
| Optical beam smoke detectors | 25 | 40 |

¹ Rapid attendance values can be used where fire brigade response time is less than 5 minutes

² According to NFPA 72 2002 table 5.6.5.5.1, heat detector spacing is reduced on ceiling heights that exceed 10 feet. All detectors (heat and smoke) shall be accessible for service and replacement. Installation must include service and replacement. Installation must include the ability to get at the smoke or heat detector. Concealed detectors must be prominently indicated as required in NFPA 72 (section 3-8.4)

Beams and Other Similar Ceiling Obstructions: Fire detectors should be mounted at least 500 mm away from walls or ceiling obstructions greater than 250 mm deep and at least twice the depth of obstructions less than 250 mm deep. They should also be mounted at least 3 ft (1 m) away from any forced air inlet. Where the obstruction is greater than 10% of the height of an area, it should be considered as a wall. Similarly a floor mounted obstruction (such as racking) should be considered a wall if it comes to within 300 mm of the height of the detector.

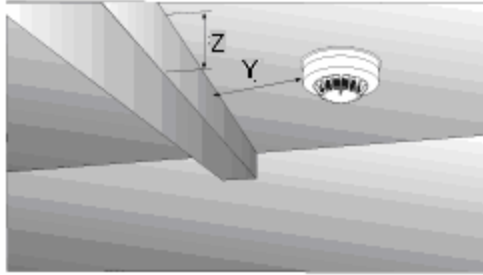

For obstructions of less than 250 mm Y should be at least 2 x Z

Lift Shafts: Where detection is required in vertical shafts, such as stairwells, a detector should be mounted at the top of the shaft and within 1.5 m at each level.

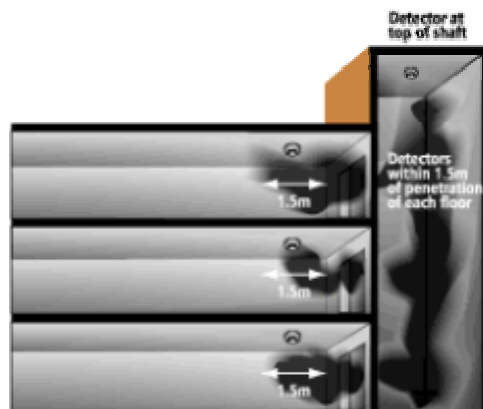

Recommendations for Smoke and Heat Detectors in Houses

With regard to the number and placement of smoke/heat detectors, subscribe to the recommendations contained in the National Fire Protection Association's (NFPA) Standard #72. Early warning fire detection is best achieved by the installation of fire detection equipment in all rooms and areas of the household as follows: For minimum protection, a smoke detector should be installed outside of each separate sleeping area and on each additional floor of a multi-floor family living unit, including basements. Note the general guidelines below:

- 1) Your smoke detector should be positioned in your house ideally on the ceiling, or on the wall, between 4-6 inches away from the ceiling-wall intersection. Be sure to place your smoke detector:
 - On the ceiling, at least 12 inches away from the wall. A fire can often "trap" pockets of air where the wall and the ceiling meet -- smoke might never reach the

smoke detector in this "dead air space" 20 feet away from "sources of combustion particles" (stoves, furnace, and water heater).

- More than one foot away from fluorescent lights.
- If the ceilings are sloped, peaked, or gabled, mount 3 feet from the highest point of the ceiling.

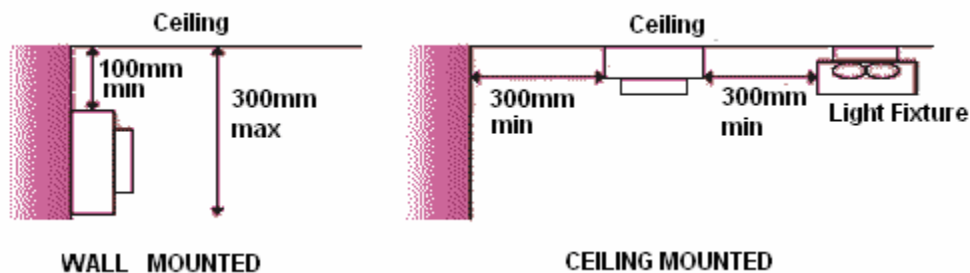

- 2) Detectors should not be located near openable windows, supply duct outlets, or other ventilation sources that would interfere with the natural air currents nor near any obstruction that would prevent smoke or heat from reaching the detector. Drafts can blow the smoke away from the smoke detector, preventing the smoke detector from sounding. Placement of detectors near air conditioning or incoming air vents can also cause excessive accumulation of dust and dirt on the detectors. This dirt can cause detectors to malfunction and cause unwanted alarms. When air supply and/or air return ducts are present in a room or space, the detector(s) should be placed in the path of the air flow toward the return air duct. Smoke detectors must be at least:

- 4 feet from ceiling supply air diffusers
- 10 feet from wall supply air diffusers.

Spot type detectors, in properly engineered systems, may also be placed in return air ducts, or in approved duct detector housings designed for this application. Although duct detectors are not a substitute for open area detectors, they can provide an effective method of initiating building control functions to prevent smoke from being transported from the fire area to other parts of a building.

Smoke tests are helpful in determining proper placement. Special attention should be given to smoke travel directions and velocity, since either can affect detector performance.

- 3) “Total coverage”, as defined in NFPA 72, is the definition of a complete fire detection system. In some of the specified areas of coverage, such as attics, closets, under open loading docks or platforms, a heat detector may be more appropriate than a smoke detector. The installation of smoke detectors in kitchens, attics (finished or unfinished), or in garages is normally not recommended. A smoke detector too close to the kitchen might frequently signal false alarms.
- 4) Detectors are usually required or recommended underneath open loading docks or platforms and their covers, and in accessible under-floor areas in buildings without basements. Detectors may be omitted from combustible blind spaces when any of the following conditions prevail:
 - The space is not accessible for storage purposes; it is protected against the entrance of unauthorized persons, and it is protected against the accumulation of windblown debris.
 - The space contains no equipment or structures (such as steam pipes, electrical wiring, ducts, shafts, or conveyors) that could potentially ignite or conduct the spread of fire.
 - The floor over the space is tight.
 - Nonflammable liquids are processed, handled, or stored on the floor above the space.
- 6) In general, when only one detector is required in a room or space, the detector should be placed as close to the center of the ceiling as possible. Central location of the detector is best for sensing fires in any part of the room. If a center location is not possible, it may be placed no closer than 4 inches from the wall, or if listed for wall mounting, it may be mounted on the wall. Wall mounted detectors should be located approximately 4 to 12 inches (10 to 30 cm) from the ceiling to the top of the detector, and at least 4 inches (10 cm) from any corner wall junction.

- 5) For additional protection, the NFPA recommends that you install heat or smoke detectors in the living room, dining room, bedroom(s), kitchen, hallway(s), attic, furnace room, utility and storage rooms, basements, and attached garages.

Where Not To Place Detectors

One of the major causes of unwanted alarms is improper placement of detectors. The best way to avoid unwanted alarms is not to install detectors in environments that can cause them to malfunction, or to install detectors specially designed for those environments. Typical examples are:

1. **Outdoors** - Avoid using detector outdoors, in open storage sheds, or other open structures affected by dust, air currents, or excessive humidity and temperature extremes.
2. **Wet or Excessively Humid Areas** - Avoid damp, wet or excessively humid areas, or next to bathrooms with showers. Water droplets can accumulate inside the sensing chamber and make the detector overly sensitive.
3. **Elevator Lobbies** - Do not place over ash trays or where people will smoke while waiting for the elevator.
4. **Extreme Cold or Hot Environments** - Avoid very cold or very hot environments, or unheated buildings or rooms where the temperature can fall below or exceed the operating temperature range of the detector. At temperatures below 0°C (32°F)*, ice crystals or condensation can appear inside the sensing chamber and make it overly sensitive or cause a false alarm. At temperatures above the operating range of the detector (greater than 49°C or 120°F), its internal components may not function properly.
5. **Areas with Combustion Particles** - Avoid areas where combustion particles are normally present, such as in kitchens or other areas with ovens and burners; in garages, where particles of combustion are present in vehicle exhausts. When a detector must be located in or adjacent to such an area, a heat detector may be appropriate.
6. **Manufacturing Areas** - Avoid manufacturing areas, battery rooms, or other areas where substantial quantities of vapors, gases, or fumes may be present. Strong vapors can make detectors overly sensitive or less sensitive than normal.

- In very large concentrations, gases heavier than air, such as carbon dioxide, may make detectors more sensitive, while gases lighter than air, such as helium, may make them less sensitive.
- Aerosol particles may collect on detector chamber surfaces and cause nuisance alarms.

7. **Fluorescent Light Fixtures** - Avoid placement near fluorescent light fixtures. Electrical noise generated by fluorescent light fixtures may cause unwanted alarms. Install detectors at least 1 foot (3 m) away from such light fixtures.

In general, unless specifically designed for the condition, smoke detectors shall not be installed if: a) temperature is below 32°F or above 100°F, b) Relative humidity is above 93 percent, and c) Air velocity is greater than 300 feet per minute. Also detectors shall not be installed until after the construction cleanup of all trades is complete and final. See Table A-5-3.6.1.2A in NFPA 72-1996 for further details.

MANUAL CALL POINTS

Manual call points or pull stations allow building occupants to signal that a fire has been observed as they leave a building. The general design philosophy is to place stations within reach along paths of escape. It is for this reason that they can usually be found near exit doors in corridors and large rooms. The selection of manual call points is somewhat simpler. Surface or flush types are selected depending on the environment and whether the fire system is being installed into an existing building (where surface call points are generally easier to install).

Standard call points use a frangible glass element which is designed to break under light pressure triggering the call point into an alarm condition. The glass element is covered with a thick plastic film to protect the operator against broken glass, however plastic resettable elements and protective flaps can be used where there is the risk of unwanted operation or in food preparation areas. Where hinged covers are used these should be recorded as a design variation. Call points can be supplied with LED indicators mounted onto the front face to simplify the location of an operated call point.

The call point for use in open circuit systems contains contacts held open by the pressure of the front plate. Breaking the plate closes the contacts and initiates an alarm. Call points for closed circuit systems operate in the reverse manner, the contacts being held in the closed position and open upon the breaking of the front plate. Alarm testing

facilities are normally provided for open circuit points. Closed circuit points do not necessarily require this facility since the circuits are continuously under test.

The advantage of manual alarm stations is that, they are simple devices, and can be highly reliable when the building is occupied.

The key disadvantage of manual stations is that they will not work when the building is unoccupied. They may also be used for malicious alarm activations. Nonetheless, they are an important component in any fire alarm system.

General Guidelines on the Manual Call points

- 1) The height of the manual fire alarm boxes shall be a minimum of 42 inches (1067 mm) and a maximum of 54 inches (1372 mm) measured vertically, from the floor level to the activating handle or lever of the box. Manual fire alarm boxes shall be red in color.
- 2) Manual call points should be located on escape routes, at all exits from each floor at the stair and corridors.
- 3) Manual fire alarm boxes (pull station) should be located not more than 5 feet (1524 mm) from the entrance to each exit.
- 4) Manual call points should be located at each door opening to the exterior of the building.
- 5) Manual call points should be located at the exit from each High-Hazard Occupancy (High-Hazard as defined by NFPA 101).
- 6) Manual pull stations should be located so that the travel distance to any station from any point in the building does not exceed 200 feet.
- 7) Manual pull stations should be located at each exit from an Assembly Occupancy (Assembly Occupancy as defined by NFPA 101).
- 8) Manual fire alarm boxes should be located in each story including basements. In buildings of Assembly Use Group, a manual fire alarm box shall be located next to the lighting control panel.
- 9) Manual call point should be located where required by NFPA 72.

- 10) Manual pull stations should be installed 42 to 54 in above the finished floor. All manual pull stations should be located to be readily accessible, unobstructed, and visible.
- 11) For general applications, call points should be located such that no one needs to travel more than 45 m to reach the nearest call point. This distance is based on measuring the actual route that would be travelled. If at the design stage the actual layout is unknown, then a straight-line distance of 30 m should be used as a design guide and the 45 m limit verified after fit out is complete.



NOTIFICATION DEVICES

Upon receiving an alarm notification, the fire alarm control panel must now alert someone that an emergency is underway. Fire alarm systems utilize a variety of devices to alert building occupants and fire authorities within the protected area as well as outside that an event or fault has occurred. These devices include:

- 1) Audible alarms (horns, bells, buzzers, chimes, etc.)
- 2) Visual alarms (strobes, etc.)
- 3) Voice Evacuation systems

Alarms

The audible types are most common, with a variety of types being available from bells to all kinds of different electronic sounders including those containing pre-recorded spoken messages. Many types of alarm sounders are available and the choice of device is dependant on local preference, legal requirement and the need to have a tone distinct from all other building audible alarms.

- 1) Bells are the most common and familiar alarm sounding device, and are appropriate for most building applications.
- 2) Horns are another option, and are especially well suited to areas where a loud signal is needed such as library stacks, and architecturally sensitive buildings where devices need partial concealment.
- 3) Chimes may be used where a soft alarm tone is preferred, such as health care facilities and theaters.
- 4) Electronic solid state sounders with mono or multi tone output normally in the range of 800 to 1000 Hz.
- 5) Small sirens operating in the range of 1,200 to 1,700 Hz. Sirens ranging widely in size from 0.17 to 11 kW generally operating in the frequency range of 400 to 800 Hz. Outdoor sirens should be fitted with heaters and thermostats to protect against low temperature conditions.
- 6) Speakers are the fourth alarm sounding option, which sound a reproducible signal such as a recorded voice message.
- 7) Voice communication capabilities can be integrated into a fire alarm system by connecting loudspeakers or public address (PA) systems located throughout the building to a central control. In these cases, the audible alarm signal operates for a predetermined period of time, after which it can be silenced while the loudspeakers are in use. These systems enable fire department personnel to instruct the building occupants on procedures to follow during the fire. They are often ideally suited for large, multistory or other similar buildings where phased evacuation is preferred.

Sound levels should generally be 65dBA or 5dBA above persistent background noise levels. This may be reduced to 60dBA in rooms smaller than 600 ft², in stairwells or in specific limited points of the building. Most sounders have adjustable output levels, which allow a balance between meeting the requirements of the standard and providing a sensible level of audible comfort. Generally more low output sounders are better than few high output sounders in this respect.

In addition to these general requirements the following specific requirements should also be noted:

- 1) A level of at least 75dBA at the bed head is required to wake sleeping occupants.

- 2) At least one sounder is required per fire compartment.
- 3) All of the sounders utilized in a building should emit a similar noise.

When considering the number and position of sounders the following should be considered:

- 1) A loss of at least 20 to 30dBA should be allowed for sound going through doors.
- 2) Where two identical sounders are in one location the level increases by only 3dBA.
- 3) The sound pressure level drops with distance according to the graph below.
- 4) It is necessary to consider cable loading requirements when designing sounder circuits. Volt drop should be limited to less than 10% of nominal voltage.
- 5) It is recommended to always err on the side of caution when selecting sounders and their locations, as it is far simpler to reduce the volume setting of a sounder where appropriate than to retrofit additional sounders should the initial levels be inadequate. Sounder output levels are normally quoted in dB (a) at 1m.

| Distance from source (m) | Reduction in DB(A) |
|--------------------------|--------------------|
| 1 | 0 |
| 2 | 6 |
| 3 | 9.2 |
| 4 | 12 |
| 5 | 13.9 |
| 6 | 15.5 |
| 7 | 16.9 |
| 8 | 18 |
| 9 | 19 |
| 10 | 20 |

| Distance from source (m) | Reduction in DB(A) |
|--------------------------|--------------------|
| 11 | 20.8 |
| 12 | 21.5 |
| 13 | 22.2 |
| 14 | 22.9 |
| 15 | 23.5 |
| 16 | 24 |
| 17 | 24.6 |
| 18 | 25.1 |
| 19 | 25.5 |
| 20 | 26 |

The graph below can be used to calculate effect on sound level at other distances in free air. In addition allowances have to be made for obstructions such as doors, the absorption of sound by furnishings the directional nature of the sounder, mounting position and location of the sounder, etc.

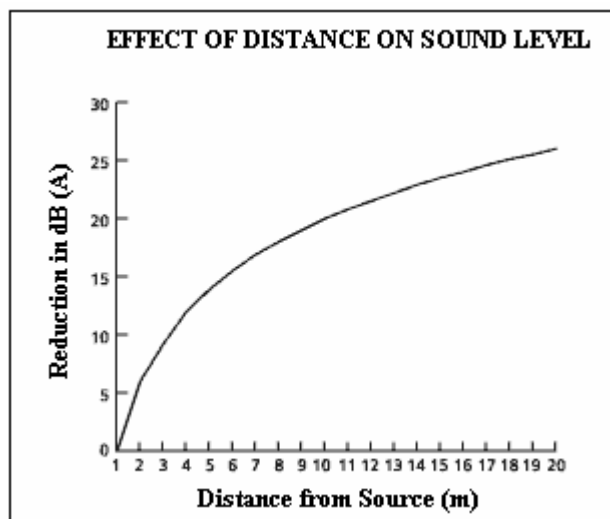

Audibility Requirements per NFPA

The total sound pressure level produced shall not exceed 120 dB (A) anywhere in the occupiable area [section 7.4.1.2]

Public Mode Audible Requirements [section 7.4.2]

7.4.2.1* To ensure that audible public mode signals are clearly heard, unless otherwise permitted by 7.4.2.2 through 7.4.2.5, they shall have a sound level at least 15 dB above the average ambient sound level or 5 dB above the maximum sound level having a duration of at least 60 seconds, whichever is greater, measured 5 ft above the floor in the occupiable area, using the A-weighted scale dB (A).

Private Mode Audible Requirements [section 7.4.3]

7.4.3.1 Audible notification appliances intended for operation in the private mode shall have a sound level of not less than 45 dB (A) at 10 ft or more than 120 dB (A) at the minimum hearing distance from the audible appliance.

7.4.3.2* To ensure that audible private mode signals are clearly heard, they shall have a sound level at least 10 dB above the average ambient sound level or 5 dB above the maximum sound level having a duration of at least 60 seconds, whichever is greater, measured 5 ft above the floor in the occupiable area, using the A-weighted scale dB (A).

Visual Alarms

With respect to visual alert, there are a number of strobe and flashing light devices. The terms visual alarm signal, visible signal device, and visible signaling appliance are used relatively interchangeably within the fire protection community; the National Fire Protection Association (NFPA) calls them visual notification appliances.

Why are Visual Alarms Required

Visual alerting is required in spaces where ambient noise levels are high enough to preclude hearing sounding equipment, and where hearing impaired occupants may be found. Visual alarms are to be used where the ambient noise is such (above 90dBA) that audible warning may not be heard, where hearing protectors are in use or where the sounder levels would need to be so high that they might impair the hearing of the building occupant.

Standards such as the Americans with Disabilities Act (ADA) mandate visual devices in numerous museum, library, and historic building applications. The new ADA Accessibility

Guidelines (ADAAG) require that where emergency warning systems are provided in new or altered construction, they must include both audible and visible alarms that meet certain technical specifications.

The Visible Notification Appliances are also useful in locating the origin of the alarm.

Voice Notification

Voice systems provide an effective means of emergency notification, because:

1. Voice messages provide more information than a tone or bell
2. Effective in causing a desired reaction from occupants
3. Reduce panic during emergencies
4. Accommodates multiple threats (*fire, security, bio, weather*)

The Life Safety Code, NFPA 101, was changed in 1983 to require voice systems in assembly occupancies where the occupancy load is 300 persons or more. This change in the Code suddenly included structures such as theaters, auditoriums, nightclubs, restaurants and even churches.

With so many devices making alarm like sounds all around us, people have become complacent to alarm sounds and signals. Combining a signal with a voice message instructing occupants what to do, has been proven to be much more effective in getting people to a safe area.

Automatic evacuation public address messages can be played over speakers located throughout the building and fire authorities can make announcements as necessary to take command of evacuation or relocation procedures and emergencies. Fire Fighter Phones or Warden Stations may be included as required.

EMERGENCY CONTROLS

Remote Communication System

Another key function of the output function is emergency response notification. The most common arrangement is an automatic telephone or radio signal that is communicated to a constantly staffed monitoring center. Upon receiving the alert, the center will then contact the appropriate fire department, providing information about the location of alarm. In some instances, the monitoring station may be the police or fire departments, or a 911 center. In other instances it will be a private monitoring company that is under

contract to the organization. In many cultural properties, the building's in-house security service may serve as the monitoring center.

Emergency Shutdown and Diagnostic Functions

Fire alarm systems can be designed to control the operation of the building service equipment to minimize the spread of fire and smoke. Signals from the system can automatically engage equipment to pressurize stairwells or shut down recirculating air systems. The alarm system can also be designed to activate smoke exhaust systems to ventilate a fire and reduce heat build-up. Controls connected to the fire alarm system can recall elevators automatically to the ground floor and remove them from public use. Fire alarm systems may also be designed to activate fire suppression systems, release hold-open devices on fire doors and indicate the location of the fire within the building. A few of the typical applications are as follows:

1. HVAC Shutdown: shutdown of respective air handler upon activation of associated duct smoke detector. Smoke detectors can be used to initiate signals to shut down fans or close dampers. In that case they are installed in the return air ducts of heating, ventilating and air-conditioning systems, to prevent the circulation of smoke-contaminated air. Duct smoke detectors shall be provided for mechanical unit shutdown as required by NFPA 90A.
2. Door Holders: release doors automatically upon activation of associated smoke detector.
3. Door Lock Release: unlock all doors with special locking arrangements as required by NFPA 101.
4. Elevator Recall: recall elevators as required by the elevator safety code.
5. Elevator Shunt Trip: operate the shunt trip circuit breaker for the elevator main line in accordance with the requirements of the elevator safety code.
6. Water Flow Detectors: Water flow detectors shall be provided to monitor sprinkler systems for water flow. Water flow detectors shall be provided for the following:
 - At each alarm check valve (Pressure switch)
 - At each dry-pipe valve (Pressure switch)
 - At each pre-action system valve (Pressure switch)

- At each sprinkler or standpipe system riser
7. Activating smoke extract fans which is a common function in large atria spaces.
 8. Activating discharge of gaseous fire extinguishing systems, or pre-action sprinkler systems and other special fire extinguishing systems, valve tamper switches, and sprinkler system control valves, water flow switches, pressure switches, fire pump supervisory alarms, suppression system activation.
 9. Fire Pump Supervision: For each fire pump provide individual supervision of the following fire pump alarms:
 - Fire pump running
 - Fire pump loss of power in any phase
 - Fire pump phase reversal
 10. High/Low Air Pressure Supervision: Provide supervision of low and high air pressure for each dry-pipe system and each pre-action system.
 11. Sprinkler/Standpipe Valves: Provide supervision for each sprinkler/standpipe system control valve.
 12. Off-Site Supervision: Provide in or adjacent to the control panel, all equipment and wiring necessary to connect to system to the remote panel. Activation of any of the following signals shall automatically be reported to remote panels via relays:
 - Fire Alarm System in Alarm
 - Valve Tamper
 - System Trouble
 - Water flow
 - Fire Alarm System Power Off

Most detectors used in releasing service (emergency shutdown services) have auxiliary relay contacts which are directly connected to the system or device to be controlled. Care should be taken to ensure that detectors utilized in such a manner are approved for releasing service. Spacing and placement requirements for detectors used in releasing service may be different from detectors used in conventional open area applications. It is

recommended that 4-wire detectors be used in these situations because depending on the control panel and detectors used, more than one detector relay on a circuit may not receive enough power from the 2-wire circuit to operate during alarm.

SUPPLEMENTARY EQUIPMENT

Power Units

The fire alarm system shall be provided with a reliable primary and secondary power supply. Both shall be reliable and have adequate capacity for the application in accordance with NFPA 72

The secondary power supply must supply energy to the system within 30 seconds and can be:

1. Battery
2. Emergency generator

The secondary power supply shall have sufficient capacity to operate a local, central station or proprietary system for 24 hours under maximum load and then, at the end of that period, operate all alarm modification appliances used for evacuation or to direct aid to the location of an emergency for 5 minutes.

The secondary power supply for emergency voice/alarm communications service shall be capable of operating the system under maximum normal load for 24 hours and then be capable of operating the system during a fire or other emergency condition for a period of 2 hours.

When the transfer from primary to secondary power supply takes place, there shall be no loss of signals.

Selection of Suitable Equipment Autonomy

Standby time for life safety systems is normally 24 hrs. For property protection this may need to be increased to up to 72hrs where the building is unoccupied over weekends.

NFPA 72 [2002] states the following for secondary power supply [section 4.4.1.5]:

4.4.1.5.1 Secondary power for protected premises

- dedicated storage battery
- dedicated branch circuit of a generator with dedicated storage battery for 4 hours

4.4.1.5.3* Capacity

- 24 hours standby – 5 minutes alarm (evacuate)
- 24 hours standby – 15 minutes alarm (Emergency Voice / Alarm Communication Systems)
- 24 hours standby – Supervising Stations

* *NFPA 72 [1999] calls for 60 hours standby for an Auxiliary or Remote Station system.*

Battery Calculations

Conventional panels and most repeater panels generally have batteries, which are sized to provide a defined level of standby autonomy based on a fully loaded system. For analogue systems, batteries are typically custom sized to suit the required configuration, because the amount and type of connected equipment can vary considerably. Recommendation: Use manufacturers' battery charts that depict the aging and discharge degradation curves for the batteries.

CABLING & WIRING TECHNIQUES

Wiring Installation Guidelines All fire alarm system installation wiring should be installed in compliance with Article 760 of NFPA 70, the National Electrical Code (NEC) the manufacturer's instructions and the requirements of the authority having jurisdiction. Fireproof cables should now be used for all parts of the system and enhanced fire resistance cables should be used where there is a requirement to ensure cable integrity over a longer period of time; for example, when connecting to alarm sounders or where the connection between sub-panels provides any part of the alarm signal path.

The primary rule of installation wiring is: "Follow the Manufacturer's Instructions".

This rule cannot be overemphasized. The requirement for electrical supervision of the installation wires and their connections to initiating devices makes fire alarm system installation wiring very different than general wiring.

A manufacturer's installation wiring drawing routes wires and shows connections in a certain manner to accommodate supervision requirements. Any variance from the manufacturer's drawings might cause a portion of a circuit to be unsupervised and, if an open or short circuit fault occurred, it could prevent the circuit from being able to perform its intended function without giving the required trouble indication.

The rules of supervision are not very complex; however, unless an installer is experienced in fire alarm system installations, he or she would not likely be familiar with them.

Smoke detector manufacturer's installation drawings will show how their detectors are to be connected into a system. However, a manufacturer's drawings may not show how devices located on the same floor, but served by a different riser (vertical wiring run), should be connected. The figure below should be considered as typical initiating device circuits utilizing smoke detectors. It illustrates proper and improper installation wiring techniques.

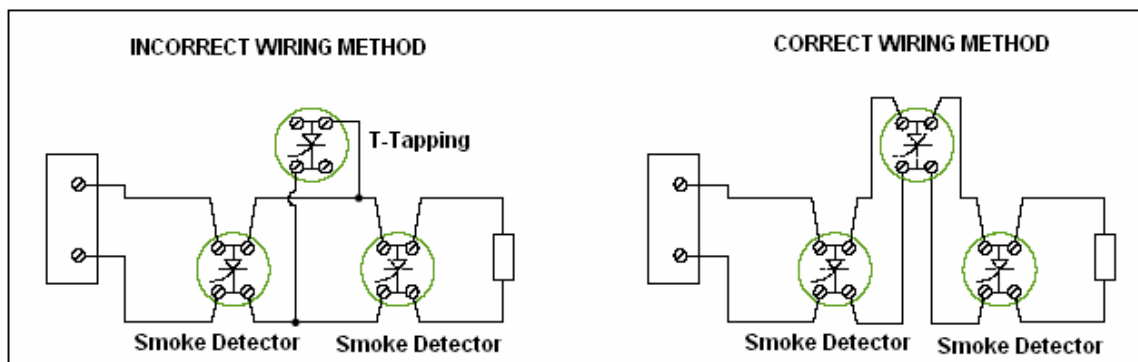

This common installation error is made in riser wiring as well as single floor wiring. The smoke detector may operate properly under alarm conditions, however, if it becomes disconnected from the installation wiring loop beyond the T-tap it would not cause a "trouble" condition to occur. "T" tapping of non-addressable initiating devices is not permitted because that practice does not provide complete supervision of all cabling, connections and devices. It may be allowable for some addressable devices, because supervision is achieved by the unique address of each module and the control's polling scheme. Refer to the manufacturer's recommendations.

The correct method of wiring installation is shown on the right side. None of the connections can be broken without opening the circuit, causing loss of supervision, and the fire alarm control panel to indicate trouble. Smoke detectors should be connected to supervised installation wiring in a manner that ensures electrical supervision of the device. Removal of a detector from its associated initiating circuit should cause the loop to open, resulting in a trouble condition. The required termination at the smoke detector may involve either screw terminals or wire pigtails. Regardless of the method utilized,

removal of the smoke detector or a single installation wire must open the initiating circuit and result in a trouble signal at the control panel.

Fire alarm cables should be segregated from the cables of other systems; they should be clearly marked, preferably colored red and should be routed through parts of the building that provide minimum risk. This latter point is particularly relevant where the use of the building is being changed; for example if a fuel store is being moved.

For life safety reasons, Fire Alarm Systems shall be installed with Class A wiring. All initiating, signal and notification circuits shall be Class A. All field wiring shall be installed in conduit. Conduit and boxes shall be sized according to National Electrical Code requirements based on the number of conductors.

ALARM CIRCUITS

Alarm Circuits should be arranged such that in the event of a single fault at least one sounder operates within the vicinity of the control equipment; or in the case of certain buildings open to large numbers of the general public, a single fault only partially reduces the alarm level. This is met by loop-powered devices or by the use of multiple alarm lines for conventional systems. As a minimum initiating device circuit wiring shall be two-conductor, twisted with integral shield and ground. Notification appliance circuits shall be minimum 14 AWG. Primary power (AC) branch circuit conductors shall be minimum 12 AWG. All conductors which are terminated, spliced, or otherwise interrupted shall be connected to terminal blocks. Make all connections with pressure type terminal blocks, which are securely mounted. The use of wire nuts or similar devices shall be prohibited.

The initiating circuits that connect smoke detectors to a control panel should be supervised so that a fault (trouble) condition that could interfere with the proper operation of the circuit will be detected and annunciated.

** Refer to the fire alarm control panel manufacturer's operating manual to determine the ability of a specific initiating circuit to react in a "Class B" or "Class A" fashion.*

- 1) **Class B Circuit** - An arrangement of supervised initiating device, signaling line, or indicating appliance circuits, which do not prevent a single open or ground on the installation wiring of these circuits from causing loss of the system's intended function.

Class B circuits differentiate between short circuits across the loop (alarm) and opens on the loop (trouble). Supervision of this circuit is accomplished by passing a low current through the installation wiring and an end-of-line device. Increases or decreases in this supervisory current are monitored by the fire alarm control panel, and will cause alarm or trouble conditions, respectively, to be indicated. A single open in a Class B circuit disables all devices electrically beyond the open.

Smoke detectors that are connected to Class B initiating device circuits are generally categorized as either 2-wire or 4-wire detectors as follows:

- Two-wire detectors derive their power directly from the same fire alarm control panel alarm initiating device circuit over which they report an alarm. Because of their dependency on the initiating circuit, 2-wire detectors should be tested and listed for compatibility to ensure proper operation.
- Four-wire detectors are powered from a separate pair of wires, and generally apply an electrical short across the associated alarm initiating device circuit to transmit an alarm.

Because they do not derive power from the alarm initiating device circuit, electrical compatibility is predicated upon the operating parameters of the power supply to which the detectors are connected. Supervision of the power to 4-wire detectors is made possible through the use of an end-of-line power supervision relay. When power is on, the relay contacts of the end-of-line relay are closed and connected in series with the end-of-line device beyond the last initiating device. Loss of power at any point in the supply circuit will cause the relay to de-energize and a trouble condition to occur.

- 2) **Class A Circuit** - An arrangement of supervised initiating device, signaling line, or indicating appliance circuits that prevents a single open or ground on the installation wiring of these circuits from causing loss of the system's intended function.

Class A circuits also differentiate between short circuits across the loop and opens on the loop. Supervision is accomplished by monitoring the level of current passing through the installation wiring and the end-of-line device, which in a Class A circuit is an integral part of the fire alarm control panel. Class A wiring must return to and be terminated in the control panel. This technique requires a minimum of four conductors to be terminated at the panel, and further requires that the fire alarm

control panel is designed to monitor Class A circuits. The additional circuitry necessary for Class A supervision enables the control panel to “condition” the initiating circuit to monitor the initiating circuit from both ends when in a trouble mode due to an open fault on the loop. This “conditioning” ensures that all devices are capable of responding and reporting an alarm despite a single open at any point in the circuit.

- 3) **Wireless Circuits** - Wireless detectors and their internal transmitters derive their operating power from their internal battery or batteries and are listed by Underwriters Laboratories, Inc. in accordance with requirements of NFPA 72. Supervision of the internal battery power source is incorporated within the smoke detector circuitry. If the battery power source depletes to the threshold specified by Underwriters Laboratories, the smoke detector will sound a local alert and initiate a trouble signal once each hour for a minimum of seven days or until the battery or batteries are replaced.

The wireless initiating devices are supervised for removal by initiating a distinct trouble signal. Each wireless device also initiates a test transmission every hour to verify the reliability of the communication circuit. Any device failing to communicate is identified on the control panel every four hours.

The faster the source of an alarm can be pinpointed, the faster action can be taken. Although formal rules for zoning are not given in fire protection codes, except for wireless devices where each smoke detector must be individually identified, it is always sensible to zone any system that contains more than a small number of detectors.

Experienced detector installers and system designers recommend the following:

- Establish at least one zone on every protected floor.
- Zone natural subdivisions of a large building, such as separate wings on a single floor.
- Minimize the number of detectors in each zone. Fewer detectors on a zone will speed up locating the fire and simplify troubleshooting.
- Install duct detectors in different zones than open-area detectors for troubleshooting and locating purposes.

DESIGN REVIEW TO MINIMIZE FALSE ALARM POTENTIAL

False alarms have the potential to cause substantial disruption to the smooth running of a business and, in addition, place a tremendous burden on fire service resources. Regular false alarms can cause building users to disregard alarm signals leading to incorrect actions in the event of a real fire situation. False alarms can broadly be divided into four categories:

1. Unwanted alarms
2. Equipment false alarms
3. Malicious false alarms
4. False alarms with good intent

Unwanted alarms are those that are caused by a combination of factors such as environmental conditions, fire like phenomena such as steam, aerosol spray or dust triggering smoke detectors or by inappropriate action by people in the building such as smoking in areas protected by smoke detectors.

The following is designed to assist with selection of equipment to avoid common potential unwanted alarm conditions:

| Area | Recommendation |
|----------------------------------|--|
| Kitchen | Smoke detectors should never be used |
| Areas close to kitchens | Avoid rate of rise heat detectors Avoid smoke detectors if possible Do not install ionization smoke detectors Consider photo thermal detector |
| Rooms in which toasters are used | Avoid smoke detectors if possible Do not install ionization smoke detectors Consider photo thermal detector |
| Rooms in which people smoke | Avoid smoke detectors if possible Do not install optical smoke detectors Consider photo thermal detector |

| Area | Recommendation |
|---|--|
| Bathrooms shower rooms and areas where steam occurs | Avoid smoke detectors if possible Do not install optical smoke detectors Consider photo thermal detector |
| Areas with high dust concentrations | Avoid smoke detectors if possible Do not install optical smoke detectors Consider photo thermal detector |
| Areas where the sensing element is subject to high air velocity | Do not install ionization smoke detectors |
| Areas in which engine exhaust fumes occur | Avoid smoke detectors if possible Do not install ionization smoke detectors Do not install beam detectors Consider photo thermal detector |
| Areas close to open able windows | Avoid smoke detectors if possible Do not install ionization smoke detectors |

Photo thermal detectors analyze both change in temperature as well as density of smoke or smoke like phenomena. This can considerably reduce the potential for false alarms. In addition with analogue systems it is possible to configure the detector to operate in heat only mode at specific times when smoke or smoke like phenomena is likely to be present and then to revert to combined smoke and heat detection when the presence of smoke is no longer expected.

MAINTENANCE

Regular testing and inspection of the fire alarm system is essential to ensure that it is operating correctly. Many of the functions of the system are monitored but it will still require an inspection of the panel by the responsible person to see the fault indication and all such events should be entered into the system log together with the implementation of an action plan to investigate the reason for the fault and a repair/correction program.

The advantage of making use of this facility is that the service department will have ready access to all spares and to information relating to possible design changes or specification enhancements that invariably happen over time.

The following minimum regular tests and inspections are recommended:

Daily - Check to see if the system is indicating fault and that any corrective actions have taken place.

Weekly - Test the system by operating a manual call point (different one each week).

Periodic Inspection - Subject to risk assessment, should not exceed 6 months between visits. Check the system log and ensure that corrective actions have taken place. Visually inspect all items of equipment, to ensure that the system is not obstructed or rendered inappropriate by change of use. Check for any false alarms, compare to nationally accepted levels and take appropriate action if unacceptable. Test the system on standby power to ensure that the battery is functioning correctly. Check all outputs for correct operation. Check all controls and indicators. Check remote signaling equipment. Additionally any other special checks; for example beam detectors for correct alignment.

Over 12 month period - Carried out over 2 or more visits. In addition to the periodic inspection: Test all manual call points and fire detectors for correct operation. Inspect the analogue detector levels to ensure that they are within correct levels. Check all alarm devices for correct operation. Visually inspect all accessible cable fixings. Confirm the cause and effect programming is correct and up to date.

How Long Will My Smoke Alarm Last?

About eight-to-ten years, after which it should be replaced. Like most electrical devices, smoke alarms wear out. You may want to write the purchase date with a marker on the inside of your unit. That way, you'll know when to replace it. Always follow the manufacturer's instructions for replacement.

SYSTEM EXTENSIONS

An extension to a fire alarm system should be planned and implemented with the same care and consideration that was given to the original system. There is always a risk that small extensions may affect the integrity of the whole system. Conventional systems can interface directly to volt free contacts by using suitable resistors (for monitoring sprinkler flow switches for example) and are provided with relay outputs in the panels to connect

to fire and fault routing equipment, fire protection equipment, etc. By definition an interface bridges the gap between two pieces of equipment or two systems; consequently it is essential to consider the requirements of both sides of the interface both from a loading point of view and with regard to functionality and typical fault scenarios.

Special care is needed if a different manufacturer is chosen for the extension to ensure that there is compatibility between the old and new equipment and to ensure that system loading constraints are met. The main area of caution is to ensure that the voltage rating of the equipment and interface are compatible. For example, 24V relay contacts should not be used to switch mains voltage, even if they appear to work and it is best to provide isolation between systems (such as protection and alarm systems) so that there is no risk of electrical interference causing false alarms.

CONSTRUCTION DOCUMENTS

Construction documents for fire alarm systems shall be submitted for review and approval prior to system installation. When the Local State Building Code requires a fire alarm system; Fire Protection Construction Documents shall show the location and number of all alarm initiating devices, alarm notification appliances, proposed zoning, and a complete sequence of operation for the system. Construction documents shall include, but not be limited to, all of the following:

1. A floor plan
2. Details of ceiling height and construction
3. Locations of alarm-initiating and notification appliances
4. Alarm control and trouble signaling equipment
5. Annunciation
6. Power connection
7. Battery calculations
 - Conductor type and sizes
8. Voltage drop calculations

Voltage calculations are crucial for proper design and operation of Notification Appliance Circuits (NACs). Under alarm condition, there must be sufficient voltage at

each notification appliance; otherwise, the appliance (*horn, speaker, or strobe*) may not work properly to provide sufficient notification for people to know to evacuate. Factors Impacting or Impacted by Voltage Drop include:

- Starting voltage from the control unit
- Voltage required at the appliance
- Length of circuit
- Circuit load (current draw of all appliances)
- Size of wiring conductors
- Calculation method

The documents must include the manufacturers, model numbers and listing information for equipment, devices and materials.

The interface of fire safety control functions

The authority having jurisdiction shall be notified prior to installation or alteration of equipment or wiring. Once the construction documents are approved, the mechanical execution of work shall be performed in workmanlike manner. Fire alarm circuits shall be installed in a neat and workmanlike manner. Cables and conductors installed exposed on the surface of ceiling and sidewalls shall be supported by structural components of the building in such a manner that the cable or conductors will not be damaged by normal building use. Such cables shall be attached to structural components by straps, staples, hangers, or similar fittings designed and installed so as not to damage the cable. The installation shall also conform to the applicable standards.

Acceptance Tests – Upon completion of the fire protective signaling system, all alarm notification devices and circuits, alarm indicating appliances and circuits, supervisory-signal initiating devices and circuits, signaling line circuits, and primary and secondary power supplies shall be subjected to a 100% acceptance test in accordance with NFPA 72 listed in Appendix A. Every fire alarm system shall include the following documentation, which shall be delivered to the Local Authority and to the building facility management group upon final acceptance of the system. The installation instructions shall include the following:

- A detailed narrative description of the system inputs, evacuation signaling, ancillary functions, and annunciation intended sequence of operations, expansion capability, application consideration, and limitations.
- Operator instructions for basic operations including alarm acknowledgement, system reset, and interpreting system output (LEDS's CRT display, and print out) operations of manual evacuation.

Concluding...

Fire alarm systems are required by law through building codes, fire codes and special acts or bylaws. The choice of a particular type of equipment to be used in a fire alarm system depends on the nature of the occupancy, the size of the building, the number of occupants and the level of protection desired. To be effective, a fire alarm system must be tailored to the building and the types of fire that could develop. The designer of the system must understand the functions and limitations of the equipment chosen to obtain maximum efficiency and safety.

To achieve the desired level of protection, many fire alarm systems will contain a combination of smoke detectors, heat detectors and manual pull boxes. The type of detector to be used in a given location depends on the nature of the fire expected, the response time desired and the service conditions in which the detector must operate. To be most effective, both smoke and heat detectors must be located on or near the ceiling of the space to be protected because that is where smoke or hot gases initially collect.

Contacting a fire engineer or other appropriate professional, who understands fire problems as well as different alarm and detection options, is usually a preferred first step to find the best system.

Be sure to use the applicable Code enforced by the jurisdiction.

DEFINITIONS

- 1) **Addressable Device** - A fire alarm system component with discreet identification that can have its status individually identified or that is used to individually control other functions.
- 2) **Addressable System Smoke/Heat Detector** - System smoke/heat detectors, which in addition to providing alarm and trouble indications to a control unit, are capable of communicating a unique identification (address).
- 3) **Air Sampling-type Detector** - A sampling-type detector consists of piping or tubing distribution from the detector unit to the area(s) to be protected. An air pump draws air from the protected area back to the detector through the air sampling ports and piping or tubing. At the detector, the air is analyzed for fire products.
- 4) **Alarm (Signal) Notification Appliance** - An electromechanical appliance that converts energy into audible or visible signal for perception as an alarm signal.
- 5) **Alarm Signal** - A signal indicating an emergency requiring immediate action, such as an alarm for fire from a manual box, a waterflow alarm, or an alarm from an automatic fire alarm system, or other emergency signal.
- 6) **Alarm Verification Feature** - A feature of automatic fire detection and alarm systems to reduce unwanted alarms, wherein automatic fire detectors must report alarm conditions for a minimum period of time or confirm alarm conditions within a given time period, after being reset, to be accepted as a valid alarm initiation signal.
- 7) **Annunciation** - A visible and/or audible indication.
- 8) **Annunciator** - A unit containing two or more indicator lamps, alpha-numeric displays, or other equivalent means in which each indication provides status information about a circuit, condition, or location.
- 9) **Authority Having Jurisdiction** - The “authority having jurisdiction” is the local state fire department as it pertains to Fire Detection and Suppression Systems.
- 10) **Automatic Fire Alarm System** - A system of controls, initiating devices and alarm signals in which all or some of the initiating circuits are activated by automatic devices, such as smoke detectors.
- 11) **Certification of Completion** - A document that acknowledges the features of installation, operation (performance), service, and equipment with representation by

the property owner, system installer, system supplier, service organization, and the authority having jurisdiction.

- 12) **Class A Circuit (Loop)** - An arrangement of supervised initiating device, signaling line, or indicating appliance circuits that prevents a single open or ground on the installation wiring of these circuits from causing loss of the system's intended function.
- 13) **Class B Circuit (Loop)** - An arrangement of supervised initiating device, signaling line, or indicating appliance circuits, which does not prevent a single open or ground on the installation wiring of these circuits from causing loss of the system's intended function.
- 14) **Combination Smoke Detector** - A smoke detector that combines two or more smoke or fire sensing techniques.
- 15) **Detector Coverage** - The recommended maximum distance between adjacent detectors or the area that a detector is designated to protect.
- 16) **Drift Compensation** - The capability of a detector to automatically adjust its alarm sensitivity to compensate for any changes over time in the factory settings for smoke and/or fire detection. In analog systems this is done by the panel.
- 17) **End of Line** - A device such as a resistor or diode placed at the end of a Class B wire loop to maintain supervision.
- 18) **End of Line Relay** - Device used to supervise power (for four-wire smoke detectors) and installed after the last device on the loop.
- 19) **Evacuation Signal** - Distinctive signal intended to be recognized by the occupants as requiring evacuation of the building.
- 20) **False Alarms** - An unwanted alarm caused by non-smoke contaminants such as dust or insects.
- 21) **Fire Alarm Control Unit (Panel)** - A system component that receives inputs from automatic and manual fire alarm devices and may supply power to detection devices and transponder(s) or off-premises transmitter(s). The control unit may also provide transfer of power to the notification appliances and transfer of condition to relays or devices connected to the control unit. The fire alarm control unit can be a local fire alarm control unit or master control unit.

- 22) **Fire** - A chemical reaction between oxygen and a combustible material where rapid oxidation results in the release of heat, light, flame and/or smoke.
- 23) **Fire Command Station (Fire Command Center)** - The principle location where the status of the detection, alarm, communications and control systems is displayed, and from which the system(s) has the capability for manual control.
- 24) **Flame Detector** - A device that detects the infrared, ultraviolet, or visible radiation produced by a fire.
- 25) **Four-wire Smoke Detector** - A smoke detector which initiates an alarm condition on two separate wires (initiating loop) apart from the two power leads.
- 26) **Heat Detector** - A device that detects abnormally high temperature or rate of temperature rise.
- 27) **Initiating Circuit** - A circuit which transmits an alarm signal initiated manually or automatically, such as a fire alarm box, smoke, heat, or flame sensing device, sprinkler waterflow alarm switch or similar device or equipment to a control panel or any similar device or equipment which, when activated, causes an alarm to be indicated or retransmitted.
- 28) **Initiating Device** - Any manually operated or automatically operated equipment which, when activated, initiates an alarm through an alarm signaling device. Example, a smoke detector, manual fire alarm box, supervisory switch, etc.
- 29) **Initiating Device Circuit (Loop)** - A circuit to which automatic or manual signal-initiating devices are connected where the signal received does not identify the individual device operated.
- 30) **Installation and Design** - All systems shall be installed in accordance with the specifications and standard approved by the authority having jurisdiction.
- 31) **Intelligent (Analog, Smart) System Smoke Detector** - A system smoke detector capable of communicating information about smoke conditions at its location to a control unit. This type of detector typically communicates a unique identification (address) along with an analog signal, which indicates the level of smoke at its location.
- 32) **Ionization Smoke Detector** - An ionization smoke detector has a small amount of radioactive material that ionizes the air in the sensing chamber, thus rendering it

conductive and permitting a current to flow between two charged electrodes. This gives the sensing chamber an effective electrical conductance. When smoke particles enter the ionization area, they decrease the conductance of the air by attaching themselves to the ions, causing a reduction in mobility. When the conductance is less than a predetermined level, the detector responds.

33) **Light Scattering** - The action of light being reflected and/or refracted by particles of combustion for detection by a photoelectric smoke detector. The action of light being refracted or reflected.

34) **Line-Type Detector** - A device in which detection is continuous along a path. Typical examples are rate-of-rise pneumatic tubing detectors, projected beam smoke detectors, and heat-sensitive cable.

35) **Listed** - Equipment or materials included in a list published by an organization acceptable to the “authority having jurisdiction” and concerned with product evaluation, that maintains periodic inspection of listed equipment or materials and whose listing states either that the equipment or material meets appropriate standards or has been tested and found suitable for use in a specified manner.

Note: The means for identifying listed equipment may vary for each organization concerned with product evaluation, some of which do not recognize equipment as listed unless it is also labeled. The “authority having jurisdiction” should utilize the system employed by the listing organization to identify a listed product.

36) **Municipal Fire Alarm System** - A system of alarm initiating devices, receiving equipment, and connecting circuits (other than a public telephone network) used to transmit alarms from street locations to the public fire service communications center.

37) **National Fire Protection Association (NFPA)** - NFPA administers the development and publishing of codes, standards, and other materials concerning all phases of fire safety.

38) **Nuisance Alarm** - An unwanted alarm caused by smoke from cooking or cigarettes.

39) **Obscuration** - A reduction in the atmospheric transparency caused by smoke usually expressed in percent per foot.

- 40) **Particles of Combustion** - Substances (products that either remain at the site of burning such as ash, or scatter as volatile products) resulting from the chemical process of a fire.
- 41) **Photoelectric Smoke Detector** - In a photoelectric light scattering smoke detector, a light source and a photosensitive sensor are so arranged that the rays from the light source do not normally fall on the photosensitive sensor. When smoke particles enter the light path, some of the light is scattered by reflection and refraction onto the sensor, causing the detector to respond.
- 42) **Pre-signal Feature** - Where permitted by the authority having jurisdiction, systems shall be permitted to have a feature where initial fire alarm signals will sound only in departments offices, control rooms, fire brigade stations, or other constantly attended central locations and where human action is subsequently required to activate a general alarm, or a feature where the control equipment delays general alarm by more than one minute after the start of the alarm processing. The areas where there is a connection to a remote location, it shall activate upon initial alarm signal.
- 43) **Primary Power Supply** - The primary supply shall have a high degree of reliability, shall have adequate capacity for the intended service.
- 44) **Projected Beam Smoke Detector** - In a projected beam detector the amount of light transmitted between a light source and a photosensitive sensor is monitored. When smoke particles are introduced into the light path, some of the light is scattered and some absorbed, thereby reducing the light reaching the receiver, causing the detector to respond.
- 45) **Positive Alarm Sequence** - An automatic series that results in an alarm signal, even if manually delayed for investigation, unless the system is reset.
- 46) **Rate-of-rise Heat Detector** - A device which will respond when the temperature rises at a rate exceeding a predetermined amount.
- 47) **Secondary Supply Capacity and Sources** - The secondary supply shall automatically supply the energy to the system within 30 seconds and without loss of signals, whenever the primary supply is incapable of providing the minimum voltage required for proper operation. The secondary (standby) power supply shall supply energy to the system in the event of total failure of the primary (main) power supply or when the primary voltage drops to a level insufficient to maintain functionality of

the control equipment and system components. Under maximum normal load, the secondary supply shall have sufficient capacity to operate a local, central station or proprietary system for 24 hours, or an auxiliary or remote station system for 60 hours; and then, at the end of that period, operate all alarm notification appliances used for evacuation or to direct aid to the location of an emergency for 5 minutes. The secondary power supply for emergency voice/alarm communications service shall be capable of operating the system under maximum normal load for 24 hours and then be capable of operating the system during a fire or other emergency condition for a period of 2 hours. Fifteen minutes of evacuation alarm operation at maximum connected load shall be considered the equivalent of 2 hours of emergency operation.

The secondary supply shall consist of one of the following:

- a) A storage battery
- b) An automatic starting engine-driven generators

Operation on secondary power shall not affect the required performance of a fire alarm system. The system shall produce the same alarm, supervisory, and trouble signals and indications (excluding the ac power indicator) when operating from the standby power source as produced when the unit is operating from the primary power source.

48) Shapes of Ceilings - Those shapes of ceilings are classified as follows:

- a) *Sloping Ceilings* – Those having a slope of more than 1 ½ in. per ft. (41.7mm per m). Sloping ceilings are further classified as follows:
 - *Sloping-Peaked Type* – Those in which the ceiling slopes in two directions from the highest point. Curved or domed ceilings may be considered peaked with the slope figured as the slope of the cord from highest to lowest point.
 - *Sloping-Shed Type* – Those in which the high point is at one side with the slope extending toward the opposite side.
- b) *Smooth Ceiling* – A surface uninterrupted by continuous projections, such as solid joists, beams, or ducts, extending more than 4 in (100 mm) below the ceiling surface.

- 49) **Single Station Alarm Device** - An assembly incorporating the detector, control equipment, and the alarm-sounding device in one unit operated from a power supply either in the unit or obtained at the point of installation.
- 50) **Smoke Detectors** - A device that detects visible or invisible particles of combustion.
- 51) **Spot Detector** - A device whose detecting element is concentrated at a particular location. Typical examples are bimetallic detectors, fusible alloy detectors, certain pneumatic rate-of-rise detectors, most smoke detectors and thermoelectric detectors.
- 52) **Stratification** - An effect that occurs when air containing smoke particles or gaseous combustion products is heated by smoldering or burning material and, becoming less dense than the surrounding cooler air, rises until it reaches a level at which there is no longer a difference in temperature between it and the surrounding air. Stratification can also be caused by forced ventilation.
- 53) **Supervision** - The ability to detect a fault condition in the installation wiring, which would prevent normal operation of the fire alarm system.
- 54) **Thermal Lag** - When a fixed temperature device operates, the temperature of the surrounding air will always be higher than the operating temperature of the device itself. This difference between the operating temperature of the device and the actual air temperature is commonly spoken of as thermal lag, and is proportional to the rate at which the temperature is rising.
- 55) **Two-wire Smoke Detector** - A smoke detector which initiates an alarm condition on the same two wires that also supply power to the detector.
- 56) **Unwanted Alarm** - Any false alarm or nuisance alarm.
- 57) **Wireless Radio Linker** - A device which receives, verifies and retransmits binary coded low power radio frequency alarm and supervisory signals generated by smoke detectors and initiating devices.
- 58) **Wireless Smoke Detector** - A smoke detector which contains an internal battery or batteries that supply power to both the smoke detector and integral radio frequency transmitter. The internal power source is supervised and degradation of the power source is communicated to the control panel.

59) **Zone** - A defined area within the protected premises. A zone may define an area from which a signal can be received, an area to which a signal can be sent, or an area in which a form of control can be executed.
