



*An Online CPD Course
brought to you by
CEDengineering.ca*

Practical Geometric Design of Roadways

Course No: C08-024
Credit: 8 PDH

Najib Gerges, Ph.D., P.E.



Continuing Education and Development, Inc.

P: (877) 322-5800
info@cedengineering.ca

Table of Contents

| | |
|--|----|
| Table of Figures..... | 2 |
| Table of Tables..... | 4 |
| 1) Section 1 — Functional Classifications..... | 5 |
| Overview | 5 |
| Traffic Volume | 5 |
| Speed | 7 |
| Design Vehicles..... | 11 |
| Terrain | 15 |
| 2) Section 2 — Design Considerations..... | 38 |
| Sight Distance..... | 38 |
| Lanes | 44 |
| Shoulders..... | 45 |
| Lanes and Shoulders Widths | 46 |
| Cross Slopes | 50 |
| Design of the Alignment..... | 52 |
| Clear Zones | 52 |
| 3) Section 3 — Horizontal Alignment..... | 54 |
| Stationing..... | 54 |
| Simple Curves | 54 |
| Compound Curves..... | 70 |
| Reverse Curves..... | 71 |
| Transition Curves | 72 |
| 4) Section 4 — Vertical Alignment | 79 |
| Terrain | 79 |
| Maximum Highway Grades | 80 |
| Length of Crest Vertical Curves..... | 83 |
| Length of Sag Vertical Curves | 88 |
| General Controls for Vertical Alignment..... | 95 |
| Combination of Vertical and Horizontal Alignment | 96 |

Table of Figures

| | |
|---|----|
| Figure 1.1 Minimum Turning Path for Passenger Car (P) Design Vehicle | 18 |
| Figure 1.2 Minimum Turning Path for Single-Unit Truck (SU-9 [SU-30]) Design Vehicle | 19 |
| Figure 1.3 Minimum Turning Path for Single-Unit Truck (SU-12 [SU-40]) Design Vehicle | 20 |
| Figure 1.4 Minimum Turning Path for Intercity Bus (BUS-12 [BUS-40]) Design Vehicle | 21 |
| Figure 1.5 Minimum Turning Path for Intercity Bus (BUS-14 [BUS-45]) Design Vehicle | 22 |
| Figure 1.6 Minimum Turning Path for City Transit Bus (CITY-BUS) Design Vehicle | 23 |
| Figure 1.7 Minimum Turning Path for Conventional School Bus (S-BUS-11 [S-BUS-36]) Design Vehicle | 24 |
| Figure 1.8 Minimum Turning Path for Large School Bus (S-BUS-12 [S-BUS-40]) Design Vehicle | 25 |
| Figure 1.9 Minimum Turning Path for Articulated Bus (A-BUS) Design Vehicle | 26 |
| Figure 1.10 Minimum Turning Path for Intermediate Semitrailer (WB-12 [WB-40]) Design Vehicle .. | 27 |
| Figure 1.11 Minimum Turning Path for Interstate Semitrailer (WB-19 [WB-62]) Design Vehicle | 28 |
| Figure 1.12 Minimum Turning Path for Interstate Semitrailer (WB-20 [WB-67]) Design Vehicle | 29 |
| Figure 1.13 Minimum Turning Path for Double-Trailer Combination (WB-20D [WB-67D]) Design Vehicle | 30 |
| Figure 1.14 Minimum Turning Path for Rocky Mountain Double-Trailer Combination (WB-28D [WB-92D]) Design Vehicle | 31 |
| Figure 1.15 Minimum Turning Path for Triple-Trailer Combination (WB-30T [WB-100T]) Design Vehicle | 32 |
| Figure 1.16 Minimum Turning Path for Turnpike-Double Combination (WB-33D [WB-109D]) Design Vehicle | 33 |
| Figure 1.17 Minimum Turning Path for Motor Home (MH) Design Vehicle | 34 |
| Figure 1.18 Minimum Turning Path for Passenger Car and Camper Trailer (P/T) Design Vehicle | 35 |
| Figure 1.19 Minimum Turning Path for Passenger Car and Boat Trailer (P/B) Design Vehicle | 36 |
| Figure 1.20 Minimum Turning Path for Motor Home and Boat Trailer (MH/B) Design Vehicle | 37 |
| Figure 2.1 Elements of and Total Passing Sight Distance on Two-Lane Highways | 42 |
| Figure 3.1 Layout of a Simple Horizontal Curve | 55 |
| Figure 3.2 Horizontal Curves with Sight-Distance Restrictions | 56 |
| Figure 3.3 Arc Definition for a Circular Curve..... | 57 |
| Figure 3.4 Deflection Angles on a Simple Circular Curve | 58 |
| Figure 3.5 Design Superelevation Rates for e_{max} of 4% (SI) | 59 |
| Figure 3.6 Design Superelevation Rates for e_{max} of 4% (US) | 60 |
| Figure 3.7 Design Superelevation Rates for e_{max} of 6% (SI) | 61 |
| Figure 3.8 Design Superelevation Rates for e_{max} of 6% (US) | 62 |
| Figure 3.9 Design Superelevation Rates for e_{max} of 8% (SI) | 63 |
| Figure 3.10 Design Superelevation Rates for e_{max} of 8% (US) | 64 |
| Figure 3.11 Design Superelevation Rates for e_{max} of 10% (SI) | 65 |
| Figure 3.12 Design Superelevation Rates for e_{max} of 10% (US) | 66 |
| Figure 3.13 Design Superelevation Rates for e_{max} of 12% (SI) | 67 |
| Figure 3.14 Design Superelevation Rates for e_{max} of 12% (US) | 68 |

Figure 3.15 Layout of a Compound Curve 70
Figure 3.16 Layout of a Reverse Curve 72
Figure 3.17 Diagrammatic Profiles Showing Methods of Attaining Superelevation for a Curve to the Right..... 78
Figure 4.1 Types of Vertical Curves 79
Figure 4.2 Parameters Considered in Determining the Length of a Crest Vertical Based on Stopping Sight Distance 84
Figure 4.3 Parameters Considered in Determining the Length of a Crest Vertical Based on Passing Sight Distance 84
Figure 4.4 Sight Distance at Under-Crossings..... 93
Figure 4.5 Layout of a Crest Vertical Curve for Design..... 95

Table of Tables

| | |
|---|----|
| Table 1.1 Minimum Design Speeds for Rural Local Roads | 8 |
| Table 1.2 Minimum Design Speeds for Rural Collector Roads | 9 |
| Table 1.3 Minimum Design Speeds for Rural Arterial Roads | 9 |
| Table 1.4 Design Vehicle Dimensions (SI Units) | 13 |
| Table 1.5 Design Vehicle Dimensions (US Units)..... | 14 |
| Table 1.6 Minimum Turning Radii of Design Vehicles (SI Units) | 16 |
| Table 1.7 Minimum Turning Radii of Design Vehicles (US Units)..... | 17 |
| Table 2.1 Stopping Sight Distance (Level Terrain)..... | 39 |
| Table 2.2 Stopping Sight Distance (Upgrades/Downgrades) | 39 |
| Table 2.3 Recommended Decision Sight Distance Values..... | 40 |
| Table 2.4 Components of Safe Passing Sight Distance on Two-Lane Highways..... | 43 |
| Table 2.5 Minimum Width of Traveled Way and Shoulders for Rural Local Roads | 47 |
| Table 2.6 Minimum Width of Traveled Way and Shoulders for Rural Collector Roads | 48 |
| Table 2.7 Minimum Width of Traveled Way and Shoulders for Rural Arterial Roads..... | 49 |
| Table 2.8 Clear Zones | 53 |
| Table 3.1 Coefficient of Side Friction for Different Design Speeds | 55 |
| Table 3.2 Minimum Radius Using Limiting Values of e and f | 69 |
| Table 3.3 Lengths of Circular Arc for Compound Curves when Followed by a Curve of One-Half Radius or Preceded by a Curve of Double Radius | 71 |
| Table 3.4 Maximum Radius for Use of a Spiral Curve Transition | 73 |
| Table 3.5 Superelevation Runoff L_r (ft) for Horizontal Curves..... | 75 |
| Table 3.6 Tangent Runout Length L_t for Spiral Curve Transition Design | 76 |
| Table 4.1 Maximum Grades for Rural Local Roads..... | 81 |
| Table 4.2 Maximum Grades for Rural Collectors | 82 |
| Table 4.3 Maximum Grades for Urban Collectors..... | 82 |
| Table 4.4 Maximum Grades for Rural Arterials..... | 82 |
| Table 4.5 Maximum Grades for Urban Arterials | 83 |
| Table 4.6 Maximum Grades for Rural and Urban Freeways | 83 |
| Table 4.7 Basic Equations for L_{min} for Crest Vertical Curves..... | 86 |
| Table 4.8 Basic Equations for L_{min} for Crest Vertical Curves Based on Stopping Sight Distance | 86 |
| Table 4.9 Design Controls for Crest Vertical Curves Based on Stopping Sight Distance | 87 |
| Table 4.10 Basic Equations for L_{min} for Crest Vertical Curves Based on Passing Sight Distance..... | 87 |
| Table 4.11 Design Controls for Crest Vertical Curves Based on Passing Sight Distance | 88 |
| Table 4.12 Basic Equations for L_{min} for Sag Vertical Curves..... | 89 |
| Table 4.13 Basic Equations for L_{min} for Sag Vertical Curves Based on Comfort..... | 90 |
| Table 4.14 Design Controls for Sag Vertical Curves Based on Stopping Sight Distance | 92 |
| Table 4.15 Case 1: Sight Distance Greater than Length of Vertical Curve ($S > L$)..... | 93 |
| Table 4.16 Case 2: Sight Distance Greater than Length of Vertical Curve ($S < L$)..... | 94 |
| Table 4.17 Case 1: Sight Distance Greater than Length of Vertical Curve ($S > L$)..... | 94 |
| Table 4.18 Case 2: Sight Distance Greater than Length of Vertical Curve ($S < L$)..... | 94 |

1) Section 1 — Functional Classifications

Overview

The first step in the design process is to define the function that the roadway is to serve. The two major considerations in functionally classifying a roadway are access and mobility. Access and mobility are inversely related; i.e., as access is increased, mobility is decreased and vice versa.

Roadways are functionally classified first as either urban or rural (depending the type of the on-site drainage system: open ditches for rural roads and inlets + pipes for urban roads). The hierarchy of the functional highway system within either the urban or rural area consists of the following:

- Freeways
- Arterials
- Collectors
- Local Roads and Streets

Traffic Volume

Traffic volume is an important basis for determining what improvements, if any, are required on a highway or street facility. Traffic volumes may be expressed in terms of average daily traffic or design hourly volumes. These volumes may be used to calculate the service flow rate, which is typically used for evaluations of geometric design alternatives.

- **Average Daily Traffic:** Average daily traffic (ADT) represents the total traffic for a year divided by 365, or the average traffic volume per day. Due to seasonal, weekly, daily, or hourly variations, ADT is generally undesirable as a basis for design, particularly for high-volume facilities. ADT should only be used as a design basis for low and moderate volume facilities, where more than two lanes unquestionably are not justified.
- **Design Hourly Volume:** The design hourly volume (DHV) is usually the 30th highest hourly volume for the design year, commonly 20 years from the time of construction completion. For situations involving high seasonal fluctuations in ADT, some adjustment of DHV may be appropriate. For two-lane rural highways, the DHV is the total traffic in both directions of travel. On highways with more than two lanes (or on two-lane roads where important intersections are encountered or where additional lanes are to be provided later), knowledge of the directional distribution of traffic during the design hour (DDHV) is essential for design. DHV and DDHV may be determined by the application of conversion factors to ADT.

Computation of DHV and DDHV: The percent of ADT occurring in the design hour (K) may be used to convert ADT to DHV as follows:

$$\text{DHV} = (\text{ADT})(\text{K})$$

The percentage of the design hourly volume that is in the predominant direction of travel (D) and K are both considered in converting ADT to DDHV as shown in the following equation:

$$\text{DDHV} = (\text{ADT})(\text{K})(\text{D})$$

- **Directional Distribution (D):** Traffic tends to be more equally divided by direction near the center of an urban area or on loop facilities. For other facilities, D factors of 60 to 70 percent frequently occur.
- **K Factors:** K is the percentage of ADT representing the 30th highest hourly volume in the design year. For typical main rural highways, K factors generally range from 12 to 18 percent. For urban facilities, K factors are typically somewhat lower, ranging from 8 to 12 percent.
- **Projected Traffic Volumes:** Projected traffic volumes are provided by the Transportation Planning and Programming (TPP) Division upon request and serve as a basis for design of proposed improvements. For high-volume facilities, a tabulation showing traffic converted to DHV or DDHV will be provided by TPP if specifically requested. Generally, however, projected traffic volume is expressed as ADT with K and D factors provided.

NOTE: If the directional ADT is known for only one direction, total ADT may be computed by multiplying the directional ADT by two for most cases.

- **Service Flow Rate:** A facility should be designed to provide sufficient capacity to accommodate the design traffic volumes (ADT, DHV, DDHV). The necessary capacity of a roadway is initially based on a set of “ideal conditions.” These conditions are then adjusted for the “actual conditions” that are predicted to exist on the roadway section. This adjusted capacity is termed service flow rate (SF) and is defined as a measure of the maximum flow rate under prevailing conditions.

Adjusting for prevailing conditions involves adjusting for variations in the following factors:

- Lane Width
- Lateral Clearances
- Free-flow Speed

- Terrain
- Distribution of Vehicle Type

Service flow rate is the traffic parameter most commonly used in capacity and level-of-service (LOS) evaluations. Knowledge of highway capacity and LOS is essential to properly fit a planned highway or street to the requirements of traffic demand. Both capacity and LOS should be evaluated in the following analyses:

- Selection of geometric design for an intersection.
- Determining the appropriate type of facility and number of lanes warranted.
- Performing ramp merge/diverge analysis.
- Performing weaving analysis and subsequent determination of weaving section lengths.

All roadway design should reflect proper consideration of capacity and level of service procedures as detailed in the TRB's Highway Capacity Manual (HCM).

Speed

Speed is one of the most important factors considered by travelers in selecting alternative routes or transportation modes. The speed of vehicles on a road depends, in addition to capabilities of the drivers and their vehicles, upon five general conditions: the physical characteristics of the roadway, the amount of roadside interference, the weather, the presence of other vehicles, and speed limitations (established either by law or by traffic control devices). Although any one of these factors may govern the travel speed, the actual travel speed on a facility usually reflects a combination of these factors.

The objective in design of any engineered facility used by the public is to satisfy the public's demand for service in an economical manner with efficient traffic operations and with low crash frequency and severity. The facility should, therefore, accommodate nearly all demands with reasonable adequacy and also should only fail under severe or extreme traffic demands.

Because only a small percentage of drivers travel at extremely high speed, it is not economically practical to design for them. They can use the roadway, of course, but will be constrained to travel at speeds less than they consider desirable. On the other hand, the speed chosen for design should not be that used by drivers under unfavorable conditions, such as inclement weather, because the roadway would then be inefficient, might result in additional crashes under favorable conditions, and would not satisfy reasonable public expectations for the facility.

There are important differences between design criteria applicable to low- and high-speed designs. For design purposes, the following definitions apply: Low-speed is 45 mph [70 km/h] and below, and High-speed is 50 mph [80 km/h] and above.

- Design Speed:** Design speed is a selected speed used to determine the various geometric design features of the roadway. The selected design speed should be a logical one with respect to the anticipated operating speed, topography, the adjacent land use, modal mix, and the functional classification of the roadway. In the selection of the design speed, every effort should be made to attain a desired combination of safety, mobility, and efficiency within the constraints of environmental quality, economics, aesthetics, and social or political impacts. The selected design speed should be consistent with the speeds that drivers are likely to travel on a given roadway. A roadway of higher functional classification may justify a higher design speed than a lesser classified facility in similar topography. A low design speed, however, should not be selected where the topography is such that drivers are likely to travel at high speeds.

The selection of design speed for a given functionally classified roadway is influenced primarily by the character of terrain, economic considerations, extent of roadside development (i.e., urban or rural), and highway type. For example, the design speed chosen would usually be less for rough terrain, or for an urban facility with frequent points of access, as opposed to a rural highway on level terrain.

Choice should be influenced by the expectations of drivers, which are closely related to traffic volume conditions, potential traffic conflicts, and topographic features.

Appropriate design speed values for the various highway classes are presented in subsequent sections. Table 1.1 shows the minimum design speeds for rural local roads.

Table 1.1 Minimum Design Speeds for Rural Local Roads

| Type of Terrain | Metric | | | | | | U.S. Customary | | | | | |
|-----------------|---|-----------|------------|-------------|--------------|---------------|--|-----------|------------|-------------|--------------|---------------|
| | Design Speed (km/h) for Specified Design Volume (veh/day) | | | | | | Design Speed (mph) for Specified Design Volume (veh/day) | | | | | |
| | under 50 | 50 to 250 | 250 to 400 | 400 to 1500 | 1500 to 2000 | 2000 and over | under 50 | 50 to 250 | 250 to 400 | 400 to 1500 | 1500 to 2000 | 2000 and over |
| Level | 50 | 50 | 60 | 80 | 80 | 80 | 30 | 30 | 40 | 50 | 50 | 50 |
| Rolling | 30 | 50 | 50 | 60 | 60 | 60 | 20 | 30 | 30 | 40 | 40 | 40 |
| Mountainous | 30 | 30 | 30 | 50 | 50 | 50 | 20 | 20 | 20 | 30 | 30 | 30 |

Concerning urban local roads, the design speed is not a major factor because in the typical street grid, the closely spaced intersections usually limit vehicular speeds. For consistency in design elements, design speeds ranging from 30 to 50 km/h [20 to 30 mph] may be used, depending on available right-of-way, terrain, likely pedestrian presence, adjacent development, and other area controls. Since the function of local streets is to provide access to adjacent property, all design elements should be consistent with the character of activity on and adjacent to the street, and should encourage speeds generally not exceeding 50 km/h [30 mph].

Table 1.2 Minimum Design Speeds for Rural Collector Roads

| Type of Terrain | Metric | | | U.S. Customary | | |
|-----------------|---|-------------|-----------|--|-------------|-----------|
| | Design speed (km/h) for Specified Design Volume (veh/day) | | | Design speed (mph) for Specified Design Volume (veh/day) | | |
| | 0 to 400 | 400 to 2000 | over 2000 | 0 to 400 | 400 to 2000 | over 2000 |
| Level | 60 | 80 | 100 | 40 | 50 | 60 |
| Rolling | 50 | 60 | 80 | 30 | 40 | 50 |
| Mountainous | 30 | 50 | 60 | 20 | 30 | 40 |

Note: Where practical, design speeds higher than those shown should be considered.

Concerning urban collector roads, the design speed is a factor in the design of collector streets. For consistency in design, a design speed of 50 km/h [30 mph] or higher should be used for urban collector streets, depending on available right-of-way, terrain, adjacent development, likely pedestrian presence, and other site controls.

Table 1.3 Minimum Design Speeds for Rural Arterial Roads

| Type of Terrain | Metric | | | | | | | | U.S. Customary | | | | | | | | |
|-----------------|---|----|----|----|-----|-----|-----|-----|--|----|----|----|----|----|----|----|----|
| | Maximum Grade (%) for Specified Design Speed (km/h) | | | | | | | | Maximum Grade (%) for Specified Design Speed (mph) | | | | | | | | |
| | 60 | 70 | 80 | 90 | 100 | 110 | 120 | 130 | 40 | 45 | 50 | 55 | 60 | 65 | 70 | 75 | 80 |
| Level | 5 | 5 | 4 | 4 | 3 | 3 | 3 | 3 | 5 | 5 | 4 | 4 | 3 | 3 | 3 | 3 | 3 |
| Rolling | 6 | 6 | 5 | 5 | 4 | 4 | 4 | 4 | 6 | 6 | 5 | 5 | 4 | 4 | 4 | 4 | 4 |
| Mountainous | 8 | 7 | 7 | 6 | 6 | 5 | 5 | 5 | 8 | 7 | 7 | 6 | 6 | 5 | 5 | 5 | 5 |

Concerning urban arterial roads, the design speeds for urban arterials generally range from 50 to 100 km/h [30 to 60 mph]. Lower speeds apply in central business districts and in more developed areas, while higher speeds are more applicable to outlying suburban and developing areas.

Concerning rural and urban freeways, and as a general consideration, the design speed should be consistent with the anticipated operating speed of the freeway during both peak and non-peak hours, but the design speed should not be so high as to exceed the limits of prudent construction, right-of-way, and socio-economic costs; however, the design speed for a freeway should not be less than 80 km/h [50 mph]. Wherever this minimum design speed is used, it is important to have a properly posted speed limit. On many urban freeways, particularly in developing areas, a design speed of 100 km/h [60 mph] or higher can be provided with little additional cost. Where the freeway corridor is relatively straight, the character of the roadway and location of interchanges may be consistent with a higher design speed. Under these conditions, a design speed of 110 km/h [70 mph] is desirable, because higher design speeds are closely related to the overall quality of a facility. For rural freeways, a design speed of 110 km/h [70 mph] should be used. In mountainous terrain, a design speed of 80 to 100 km/h [50 to 60 mph] is consistent with the driver's expectancy and may be used.

- **Operating Speed:** Operating speed is the speed at which drivers are observed operating their vehicles during free-flow conditions. The 85th percentile of the distribution of observed speeds is the most frequently used measure of the operating speed associated with a particular location or geometric feature. The following geometric design and traffic demand features may have direct impacts on the operating speed: horizontal curve radius, grade, access density, median treatments, on-street parking, signal density, vehicular traffic volume, and pedestrian and bicycle activity.
- **Posted Speed:** Posted speed refers to the maximum speed limit posted on a section of highway. Several DOT's Procedure for Establishing Speed Zones Manual states that the posted speed should be based primarily upon the 85th percentile speed when adequate speed samples can be secured. Speed zoning guidelines permit consideration of other factors such as roadside development, road and shoulder surface characteristics, public input, and pedestrian and bicycle activity.
- **Running Speed:** Running speed is the speed at which an individual vehicle travels over a highway section. The running speed is the length of the highway section divided by the time for a typical vehicle to travel through the section. For extended sections of roadway that include multiple roadway types, the average running speed is the most appropriate measure for evaluating level of service and road user costs. The average running speed is the sum of the distances traveled by vehicles on a highway section during a specified period of time divided by the sum of the travel times. The average running speed on a given roadway varies during the day, depending primarily

on the traffic volume; therefore, when reference is made to a running speed, it should be clearly stated whether this speed represents peak hours, off-peak hours, or an average for the day. Peak and off-peak running speeds are used in design and operation; average running speeds for an entire day are used in economic analyses.

Design Vehicles

- **General Characteristics:** Key controls in geometric highway design are the physical characteristics and the proportions of vehicles of various sizes using the highway; therefore, it is appropriate to examine all vehicle types, establish general class groupings, and select vehicles of representative sizes within each class for design use. These selected vehicles, with representative weight, dimensions, and operating characteristics, are used to establish highway design controls for accommodating designated vehicle classes and are known as design vehicles. For purposes of geometric design, each design vehicle has larger physical dimensions and a larger minimum turning radius than most vehicles in its class. The largest design vehicles are usually accommodated in freeway design.

Four general classes of design vehicles have been established: (1) passenger cars, (2) buses, (3) trucks, and (4) recreational vehicles. The passenger-car class includes passenger cars of all sizes, sport/utility vehicles, minivans, vans, and pick-up trucks. Buses include intercity (motor coaches), city transit, school, and articulated buses. The truck class includes single-unit trucks, truck tractor-semitrailer combinations, and truck tractors with semitrailers in combination with full trailers. Recreational vehicles include motor homes, cars with camper trailers, cars with boat trailers, motor homes with boat trailers, and motor homes pulling cars. In addition, the bicycle should also be considered as a design vehicle where bicycle use is allowed on a highway.

Dimensions for 20 design vehicles representing vehicles within these general classes are given in Tables 1.4 and 1.5. In the design of any highway facility, the designer should consider the largest design vehicle that is likely to use that facility with considerable frequency or a design vehicle with special characteristics appropriate to a particular location in determining the design of such critical features as radii at intersections and radii of turning roadways. In addition, as a general guide, the following may be considered when selecting a design vehicle:

- A passenger car may be selected when the main traffic generator is a parking lot or series of parking lots.

- A two-axle single-unit truck may be used for intersection design of residential streets and park roads.
- A three-axle single-unit truck may be used for the design of collector streets and other facilities where larger single-unit trucks are likely.
- A city transit bus may be used in the design of state highway intersections with city streets that are designated bus routes and that have relatively few large trucks using them.

Depending on expected usage, a large school bus (84 passengers) or a conventional school bus (65 passengers) may be used for the design of intersections of highways with low-volume county highways and township/local roads under 400 ADT. The school bus may also be appropriate for the design of some subdivision street intersections.

The WB-20 [WB 67] truck should generally be the minimum size design vehicle considered for intersections of freeway ramp terminals with arterial crossroads and for other intersections on state highways and industrialized streets that carry high volumes of traffic or that provide local access for large trucks, or both. In many cases, operators of WB-20 [WB-67] and larger vehicles pull the rear axles of the vehicle forward to maintain a kingpin-to-rear-axle distance of 12.5 m [41 ft], which makes the truck more maneuverable and is required by law in many jurisdictions. Where this practice is prevalent, the WB-19 [WB-62] may be used in design for turning maneuvers, but the WB-20 [WB-67] should be used in design situations where the overall length of the vehicle is considered, such as for sight distance at railroad highway grade crossings.

Recent research has developed several design vehicles larger than those presented here, with overall lengths up to 39.41 m [129.3 ft]. These larger design vehicles are not generally needed for design to accommodate the current truck fleet.

Table 1.4 Design Vehicle Dimensions (SI Units)

| Design Vehicle Type | Symbol | Dimensions (m) | | | | | | | | | | | Typical Kingpin to Center of Rear Tandem Axle |
|---|---------------------|----------------|-------|--------|----------|-------------------|-----------------|-----------------|-------------------|-------------------|-----------------|-----------------|---|
| | | Overall | | | Overhang | | WB ₁ | WB ₂ | S | T | WB ₃ | WB ₄ | |
| | | Height | Width | Length | Front | Rear | | | | | | | |
| Passenger Car | P | 1.30 | 2.13 | 5.79 | 0.91 | 1.52 | 3.35 | – | – | – | – | – | – |
| Single-Unit Truck | SU-9 | 3.35–4.11 | 2.44 | 9.14 | 1.22 | 1.83 | 6.10 | – | – | – | – | – | – |
| Single-Unit Truck (three-axle) | SU-12 | 3.35–4.11 | 2.44 | 12.04 | 1.22 | 3.20 | 7.62 | – | – | – | – | – | – |
| Buses | | | | | | | | | | | | | |
| Intercity Bus (Motor Coaches) | BUS-12 | 3.66 | 2.59 | 12.36 | 1.93 | 2.73 ^d | 7.70 | – | – | – | – | – | – |
| | BUS-14 | 3.66 | 2.59 | 13.06 | 1.89 | 2.73 ^b | 8.69 | – | – | – | – | – | – |
| City Transit Bus | CITY-BUS | 3.20 | 2.59 | 12.19 | 2.13 | 2.44 | 7.62 | – | – | – | – | – | – |
| Conventional School Bus (65 pass.) | S-BUS 11 | 3.20 | 2.44 | 10.91 | 0.79 | 3.66 | 6.49 | – | – | – | – | – | – |
| Large School Bus (84 pass.) | S-BUS 12 | 3.20 | 2.44 | 12.19 | 2.13 | 3.96 | 6.10 | – | – | – | – | – | – |
| Articulated Bus | A-BUS | 3.35 | 2.59 | 18.29 | 2.62 | 3.05 | 6.71 | 5.91 | 1.89 ^b | 4.02 ^b | – | – | – |
| Combination Trucks | | | | | | | | | | | | | |
| Intermediate Semitrailer | WB-12 | 4.11 | 2.44 | 13.87 | 0.91 | 1.37 ^d | 3.81 | 7.77 | – | – | – | – | 7.77 |
| Interstate Semitrailer | WB-19 ^a | 4.11 | 2.59 | 21.03 | 1.22 | 1.37 ^d | 5.94 | 12.50 | – | – | – | – | 12.50 |
| Interstate Semitrailer | WB-20 ^{**} | 4.11 | 2.59 | 22.40 | 1.22 | 1.37 ^d | 5.94 | 13.87 | – | – | – | – | 13.87 |
| "Double-Bottom" Semitrailer/Trailer | WB-20D | 4.11 | 2.59 | 22.04 | 0.71 | 0.91 | 3.35 | 7.01 | 0.91 ^c | 2.13 ^c | 6.06 | – | 7.01 |
| Rocky Mountain Double-Semitrailer/Trailer | WB-28D | 4.11 | 2.59 | 29.67 | 0.71 | 0.91 | 5.33 | 12.19 | 1.37 | 2.13 | 6.06 | – | 12.34 |
| Triple-Semitrailer/Trailers | WB-30T | 4.11 | 2.59 | 31.94 | 0.71 | 0.91 | 3.35 | 6.86 | 0.91 ^d | 2.13 ^d | 6.06 | 6.06 | 7.01 |
| Turnpike Double-Semitrailer/Trailer | WB-33D ^a | 4.11 | 2.59 | 34.75 | 0.71 | 1.37 ^d | 3.72 | 12.19 | 1.37 ^e | 3.05 ^e | 12.19 | – | 12.34 |
| Recreational Vehicles | | | | | | | | | | | | | |
| Motor Home | MH | 3.66 | 2.44 | 9.14 | 1.22 | 1.83 | 6.10 | – | – | – | – | – | – |
| Car and Camper Trailer | P/T | 3.05 | 2.44 | 14.84 | 0.91 | 3.66 | 3.35 | – | 1.52 | 5.39 | – | – | – |
| Car and Boat Trailer | P/B | – | 2.44 | 12.80 | 0.91 | 2.44 | 3.35 | – | 1.52 | 4.57 | – | – | – |
| Motor Home and Boat Trailer | MH/B | 3.66 | 2.44 | 16.15 | 1.22 | 2.44 | 6.10 | – | 1.83 | 4.57 | – | – | – |

Note: Since vehicles are manufactured using U.S. Customary dimensions, and to provide only one physical size for each design vehicle, the metric values shown in the design vehicle drawings have been soft converted from the values listed in feet and then rounded to the nearest hundredth of a meter.

^a Design vehicle with 14.63-m trailer as adopted in 1982 Surface Transportation Assistance Act (STAA).

^{**} Design vehicle with 16.15-m trailer as grandfathered in with 1982 Surface Transportation Assistance Act (STAA).

^d This is the length of the overhang from the back axle of the tandem axle assembly.

^b Combined dimension is 5.91 m and articulating section is 1.22 m wide.

^c Combined dimension is typically 3.05 m.

^d Combined dimension is typically 3.05 m.

^e Combined dimension is typically 3.81 m.

- WB₁, WB₂, WB₃, and WB₄ are the effective vehicle wheelbases, or distances between axle groups, starting at the front and working towards the back of each unit.
- S is the distance from the rear effective axle to the hitch point or point of articulation.
- T is the distance from the hitch point or point of articulation measured back to the center of the next axle or the center of the tandem axle assembly.

Table 1.5 Design Vehicle Dimensions (US Units)

| Design Vehicle Type | Symbol | Dimensions (ft) | | | | | | | | | | | |
|---|----------------------|-----------------|-------|--------|----------|------------------|-----------------|-----------------|------------------|-------------------|-----------------|-----------------|---|
| | | Overall | | | Overhang | | WB ₁ | WB ₂ | S | T | WB ₃ | WB ₄ | Typical Kingpin to Center of Rear Tandem Axle |
| | | Height | Width | Length | Front | Rear | | | | | | | |
| Passenger Car | P | 4.3 | 7.0 | 19.0 | 3.0 | 5.0 | 11.0 | – | – | – | – | – | – |
| Single-Unit Truck | SU-30 | 11.0–13.5 | 8.0 | 30.0 | 4.0 | 6.0 | 20.0 | – | – | – | – | – | – |
| Single-Unit Truck (three-axle) | SU-40 | 11.0–13.5 | 8.0 | 39.5 | 4.0 | 10.5 | 25.0 | – | – | – | – | – | – |
| Buses | | | | | | | | | | | | | |
| Intercity Bus (Motor Coaches) | BUS-40 | 12.0 | 8.5 | 40.5 | 6.3 | 9.0 ^d | 25.3 | – | – | – | – | – | – |
| | BUS-45 | 12.0 | 8.5 | 45.5 | 6.2 | 9.0 ^d | 28.5 | – | – | – | – | – | – |
| City Transit Bus | CITY-BUS | 10.5 | 8.5 | 40.0 | 7.0 | 8.0 | 25.0 | – | – | – | – | – | – |
| Conventional School Bus (65 pass.) | S-BUS 36 | 10.5 | 8.0 | 35.8 | 2.5 | 12.0 | 21.3 | – | – | – | – | – | – |
| Large School Bus (84 pass.) | S-BUS 40 | 10.5 | 8.0 | 40.0 | 7.0 | 13.0 | 20.0 | – | – | – | – | – | – |
| Articulated Bus | A-BUS | 11.0 | 8.5 | 60.0 | 8.6 | 10.0 | 22.0 | 19.4 | 6.2 ^b | 13.2 ^b | – | – | – |
| Combination Trucks | | | | | | | | | | | | | |
| Intermediate Semitrailer | WB-40 | 13.5 | 8.0 | 45.5 | 3.0 | 4.5 ^d | 12.5 | 25.5 | – | – | – | – | 25.5 |
| Interstate Semitrailer | WB-62 ^e | 13.5 | 8.5 | 69.0 | 4.0 | 4.5 ^d | 19.5 | 41.0 | – | – | – | – | 41.0 |
| Interstate Semitrailer | WB-67 ^{e*} | 13.5 | 8.5 | 73.5 | 4.0 | 4.5 ^d | 19.5 | 45.5 | – | – | – | – | 45.5 |
| "Double-Bottom" Semitrailer/Trailer | WB-67D | 13.5 | 8.5 | 72.3 | 2.3 | 3.0 | 11.0 | 23.0 | 3.0 ^d | 7.0 ^d | 22.5 | – | 23.0 |
| Rocky Mountain Double-Semitrailer/Trailer | WB-92D | 13.5 | 8.5 | 97.3 | 2.3 | 3.0 | 17.5 | 40.0 | 4.5 | 7.0 | 22.5 | – | 40.5 |
| Triple-Semitrailer/Trailers | WB-100T | 13.5 | 8.5 | 104.8 | 2.3 | 3.0 | 11.0 | 22.5 | 3.0 ^d | 7.0 ^d | 22.5 | 22.5 | 23.0 |
| Turnpike Double-Semitrailer/Trailer | WB-109D ^e | 13.5 | 8.5 | 114.0 | 2.3 | 4.5 ^d | 12.2 | 40.0 | 4.5 ^d | 10.0 ^d | 40.0 | – | 40.5 |
| Recreational Vehicles | | | | | | | | | | | | | |
| Motor Home | MH | 12.0 | 8.0 | 30.0 | 4.0 | 6.0 | 20.0 | – | – | – | – | – | – |
| Car and Camper Trailer | P/T | 10.0 | 8.0 | 48.7 | 3.0 | 12.0 | 11.0 | – | 5.0 | 17.7 | – | – | – |
| Car and Boat Trailer | P/B | – | 8.0 | 42.0 | 3.0 | 8.0 | 11.0 | – | 5.0 | 15.0 | – | – | – |
| Motor Home and Boat Trailer | MH/B | 12.0 | 8.0 | 53.0 | 4.0 | 8.0 | 20.0 | – | 6.0 | 15.0 | – | – | – |

^a Design vehicle with 48.0-ft trailer as adopted in 1982 Surface Transportation Assistance Act (STAA).

^{**} Design vehicle with 53.0-ft trailer as grandfathered in with 1982 Surface Transportation Assistance Act (STAA).

^d This is the length of the overhang from the back axle of the tandem axle assembly.

^b Combined dimension is 19.4 ft and articulating section is 4.0 ft wide.

^c Combined dimension is typically 10.0 ft.

^d Combined dimension is typically 10.0 ft.

^e Combined dimension is typically 12.5 ft.

- WB₁, WB₂, WB₃, and WB₄ are the effective vehicle wheelbases, or distances between axle groups, starting at the front and working towards the back of each unit.
- S is the distance from the rear effective axle to the hitch point or point of articulation.
- T is the distance from the hitch point or point of articulation measured back to the center of the next axle or the center of the tandem axle assembly.

- **Minimum Turning Paths of Design Vehicles:** Tables 1.6 and 1.7 and Figures 1.1 through 1.20 present the minimum turning radii for 20 typical design vehicles. The principal dimensions affecting design are the minimum centerline turning radius (CTR), the out-to-out track width, the wheelbase, and the path of the inner rear tire. Effects of driver characteristics (such as the speed at which the driver makes a turn) and of the slip angles of wheels are minimized by assuming that the speed of the vehicle for the minimum turning radius is less than 15 km/h [10 mph].

The boundaries of the turning paths of each design vehicle for its sharpest turns are established by the outer trace of the front overhang and the path of the inner rear wheel. This sharpest turn assumes that the outer front wheel follows the circular arc defining the minimum centerline turning radius as determined by the vehicle steering mechanism. The minimum radii of the outside and inside wheel paths and the centerline turning radii (CTR) for specific design vehicles are given in Tables 1.6 and 1.7, and in and Figures 1.1 through 1.20 .

Trucks and buses generally need more generous geometric designs than do passenger vehicles. This is largely because trucks and buses are wider and have longer wheelbases and greater minimum turning radii, which are the principal vehicle dimensions affecting horizontal alignment and cross section. Single unit trucks and buses have smaller minimum turning radii than most combination vehicles, but because of their greater off-tracking, the longer combination vehicles need greater turning path widths.

Terrain

Level, rolling, or mountainous are the types of terrain presented when choosing the appropriate design criteria and design considerations, as specified in AASHTO's A Policy on Geometric Design for Highways and Streets.

Definitions of level, rolling, and mountainous terrain are as follows:

- **Level terrain** segments contain flat grades of 2 percent or less.
- **Rolling terrain** segments contain short or medium length grades of 4 percent or less.
- **Mountainous terrain** segments contain grades of more than 4%.

Table 1.6 Minimum Turning Radii of Design Vehicles (SI Units)

| Design Vehicle Type | Passenger Car | Single-Unit Truck | Single-Unit Truck (Three Axle) | Intercity Bus (Motor Coach) | | City Transit Bus | Conventional School Bus (65 pass.) | Large ^d School Bus (84 pass.) | Articulated Bus | Intermediate Semi-trailer |
|---|-------------------------|---------------------|---|-----------------------------|------------------------------|--------------------------------------|------------------------------------|--|----------------------|-----------------------------|
| Symbol | P | SU-9 | SU-12 | BUS-12 | BUS-14 | CITY-BUS | S-BUS11 | S-BUS12 | A-BUS | WB-12 |
| Minimum Design Turning Radius (m) | 7.26 | 12.73 | 15.60 | 12.70 | 13.40 | 12.80 | 11.75 | 11.92 | 12.00 | 12.16 |
| Center-line ^b Turning Radius (CTR) (m) | 6.40 | 11.58 | 14.46 | 11.53 | 12.25 | 11.52 | 10.64 | 10.79 | 10.82 | 10.97 |
| Minimum Inside Radius (m) | 4.39 | 8.64 | 11.09 | 7.41 | 7.54 | 7.45 | 7.25 | 7.71 | 6.49 | 5.88 |
| Design Vehicle Type | Interstate Semi-trailer | | ^a Double Bottom ^a Combination | Rocky Mtn Double | Triple Semi-trailer/trailers | Turnpike Double Semi-trailer/trailer | Motor Home | Car and Camper Trailer | Car and Boat Trailer | Motor Home and Boat Trailer |
| Symbol | WB-19 ^a | WB-20 ^{a*} | WB-200 | WB-280 | WB-30T | WB-330 ^a | MH | P/T | P/B | MH/B |
| Minimum Design Turning Radius (m) | 13.66 | 13.66 | 13.67 | 24.98 | 13.67 | 18.25 | 12.11 | 10.03 | 7.26 | 15.19 |
| Center-line ^b Turning Radius (CTR) (m) | 12.50 | 12.50 | 12.47 | 23.77 | 12.47 | 17.04 | 10.97 | 9.14 | 6.40 | 14.02 |
| Minimum Inside Radius (m) | 2.25 | 0.59 | 3.83 | 16.94 | 2.96 | 4.19 | 7.92 | 5.58 | 2.44 | 10.67 |

Note: Numbers in table have been rounded to the nearest hundredth of a meter.

^a Design vehicle with 14.63-m trailer as adopted in 1982 Surface Transportation Assistance Act (STAA).

^{a*} Design vehicle with 16.15-m trailer as grandfathered in with 1982 Surface Transportation Assistance Act (STAA).

^d School buses are manufactured from 42-passenger to 84-passenger sizes. This corresponds to wheelbase lengths of 3.35 to 6.10 m, respectively. For these different sizes, the minimum design turning radii vary from 8.58 to 11.92 m and the minimum inside radii vary from 5.38 to 7.1 m.

^b The turning radius assumed by a designer when investigating possible turning paths and is set at the centerline of the front axle of a vehicle. If the minimum turning path is assumed, the CTR approximately equals the minimum design turning radius minus one-half the front width of the vehicle.

Table 1.7 Minimum Turning Radii of Design Vehicles (US Units)

| Design Vehicle Type | Passenger Car | Single-Unit Truck | Single-Unit Truck (Three Axle) | Intercity Bus (Motor Coach) | | City Transit Bus | Conventional School Bus (65 pass.) | Large ^q School Bus (84 pass.) | Articulated Bus | Intermediate Semi-trailer |
|--|-------------------------|---------------------|---|-----------------------------|------------------------------|--------------------------------------|------------------------------------|--|----------------------|-----------------------------|
| Symbol | P | SU-30 | SU-40 | BU5-40 | BU5-45 | CITY-BUS | S-BUS36 | S-BUS40 | A-BUS | WB-40 |
| Minimum Design Turning Radius (ft) | 23.8 | 41.8 | 51.2 | 41.7 | 44.0 | 41.6 | 38.6 | 39.1 | 39.4 | 39.9 |
| Center-line ^b Turning Radius (CTR) (ft) | 21.0 | 38.0 | 47.4 | 37.8 | 40.2 | 37.8 | 34.9 | 35.4 | 35.5 | 36.0 |
| Minimum Inside Radius (ft) | 14.4 | 28.4 | 36.4 | 24.3 | 24.7 | 24.5 | 23.8 | 25.3 | 21.3 | 19.3 |
| Design Vehicle Type | Interstate Semi-trailer | | ^q Double Bottom ^r Combination | Rocky Mtn Double | Triple Semi-trailer/trailers | Turnpike Double Semi-trailer/trailer | Motor Home | Car and Camper Trailer | Car and Boat Trailer | Motor Home and Boat Trailer |
| Symbol | WB-62 [*] | WB-67 ^{**} | WB-67D | WB-92D | WB-100T | WB-109D [*] | MH | P/T | P/B | MH/B |
| Minimum Design Turning Radius (ft) | 44.8 | 44.8 | 44.8 | 82.0 | 44.8 | 59.9 | 39.7 | 32.9 | 23.8 | 49.8 |
| Center-line ^b Turning Radius (CTR) (ft) | 41.0 | 41.0 | 40.9 | 78.0 | 40.9 | 55.9 | 36.0 | 30.0 | 21.0 | 46.0 |
| Minimum Inside Radius (ft) | 7.4 | 1.9 | 19.1 | 55.6 | 9.7 | 13.8 | 26.0 | 18.3 | 8.0 | 35.0 |

* Design vehicle with 48-ft trailer as adopted in 1982 Surface Transportation Assistance Act (STAA).

** Design vehicle with 53-ft trailer as grandfathered in with 1982 Surface Transportation Assistance Act (STAA).

^q School buses are manufactured from 42-passenger to 84-passenger sizes. This corresponds to wheelbase lengths of 11.0 to 20.0 ft, respectively. For these different sizes, the minimum design turning radii vary from 28.1 to 39.1 ft and the minimum inside radii vary from 17.7 to 25.3 ft.

^b The turning radius assumed by a designer when investigating possible turning paths and is set at the centerline of the front axle of a vehicle. If the minimum turning path is assumed, the CTR approximately equals the minimum design turning radius minus one-half the front width of the vehicle.

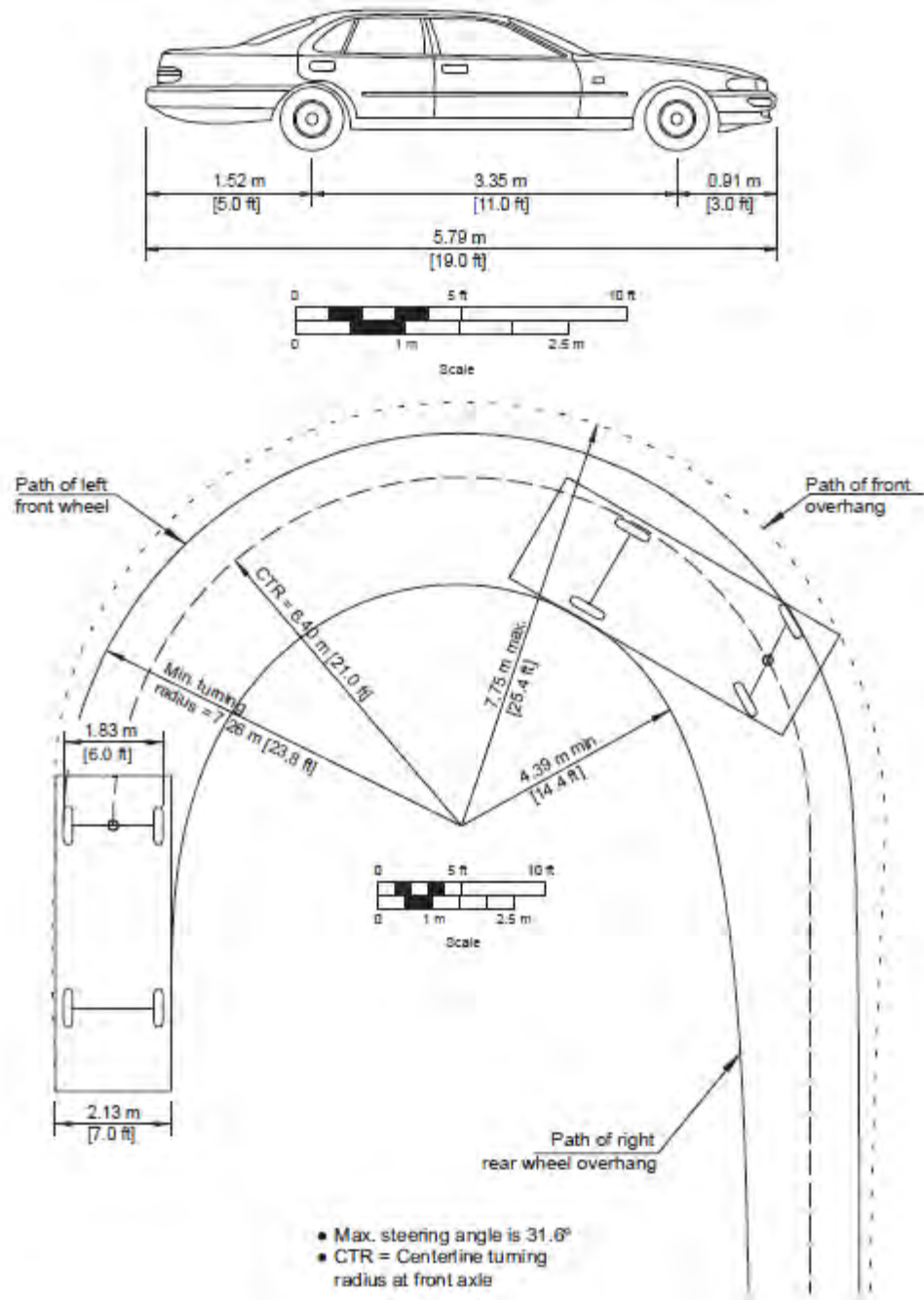

Figure 1.1 Minimum Turning Path for Passenger Car (P) Design Vehicle

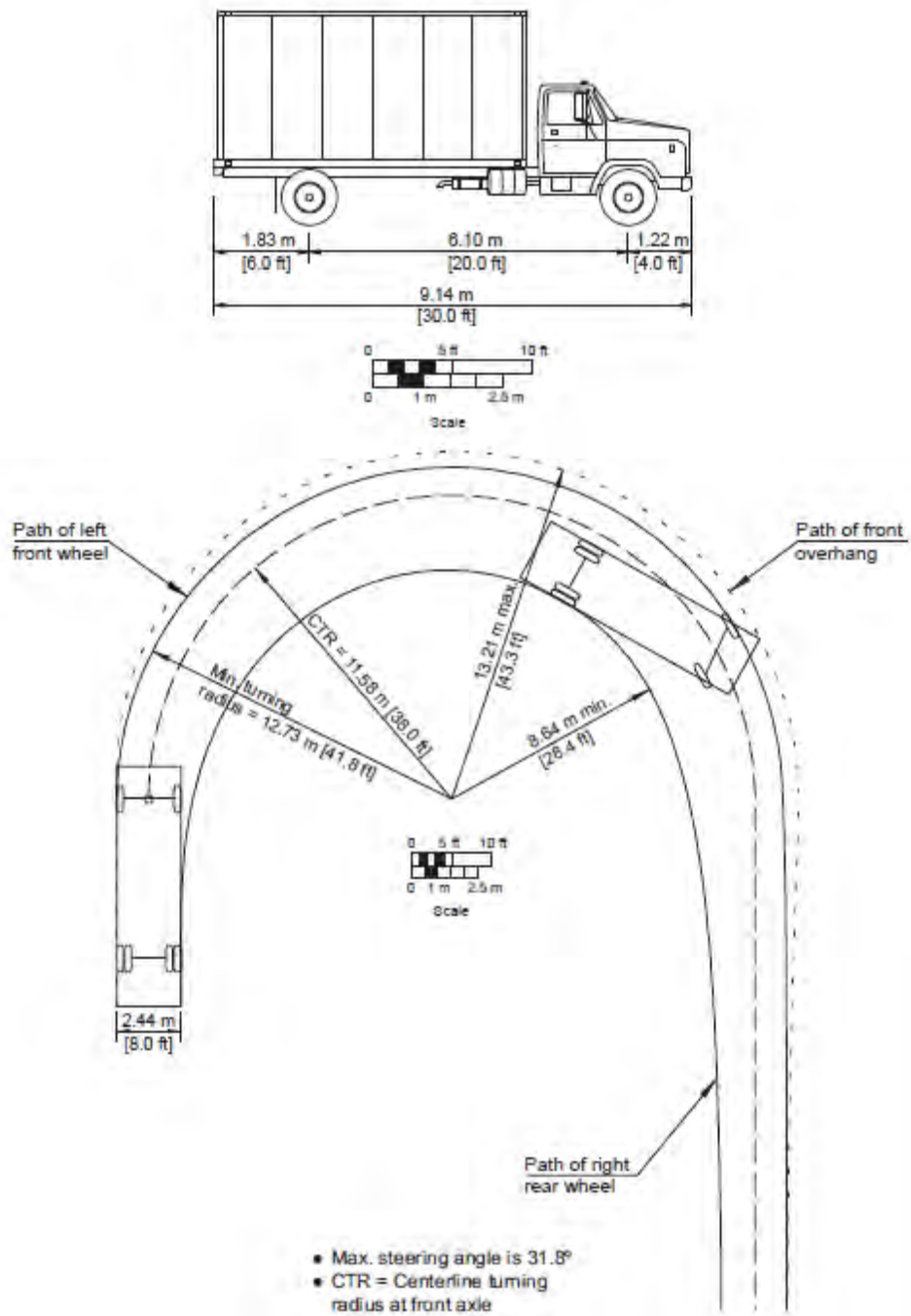

Figure 1.2 Minimum Turning Path for Single-Unit Truck (SU-9 [SU-30]) Design Vehicle

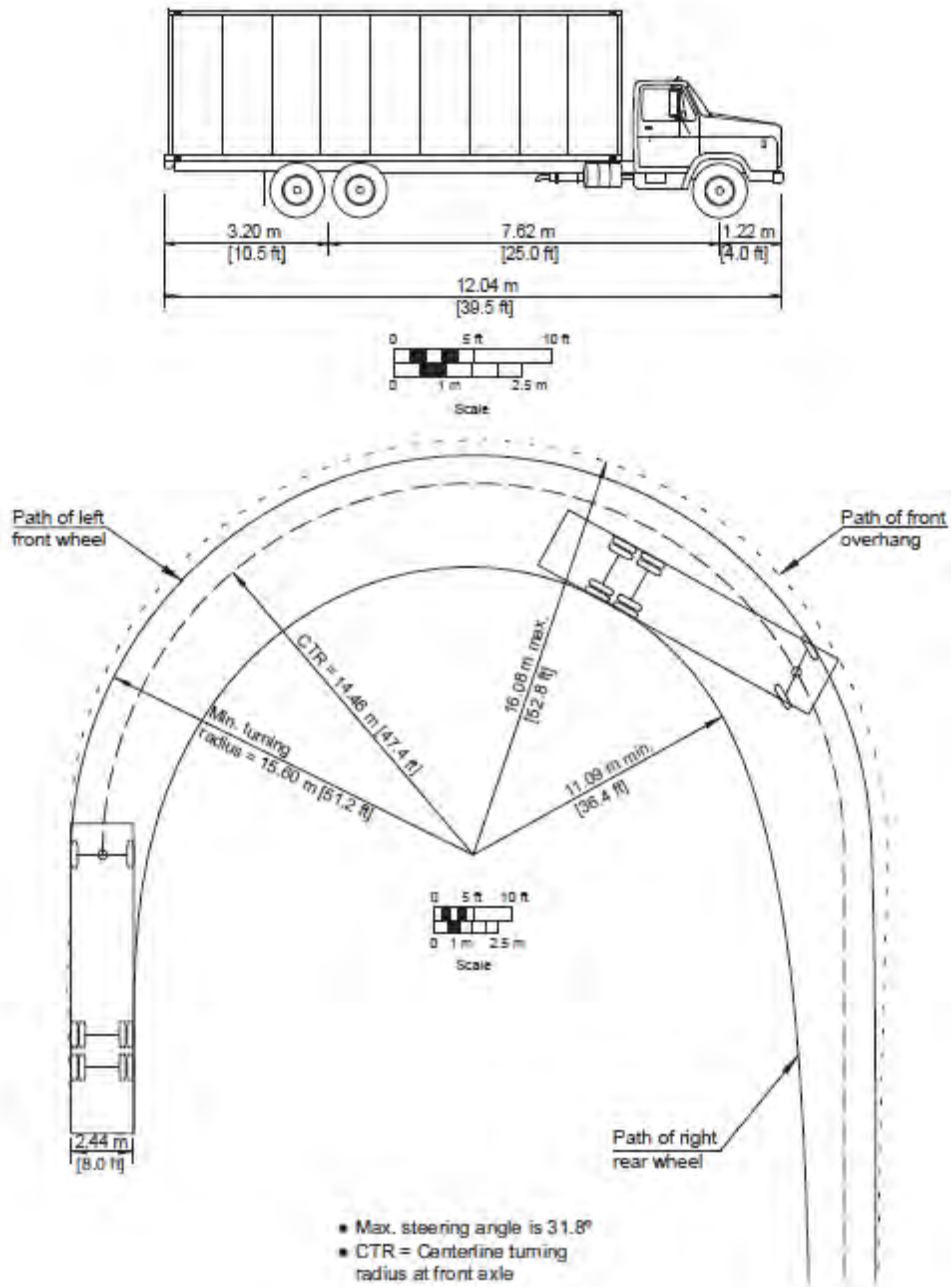

Figure 1.3 Minimum Turning Path for Single-Unit Truck (SU-12 [SU-40]) Design Vehicle

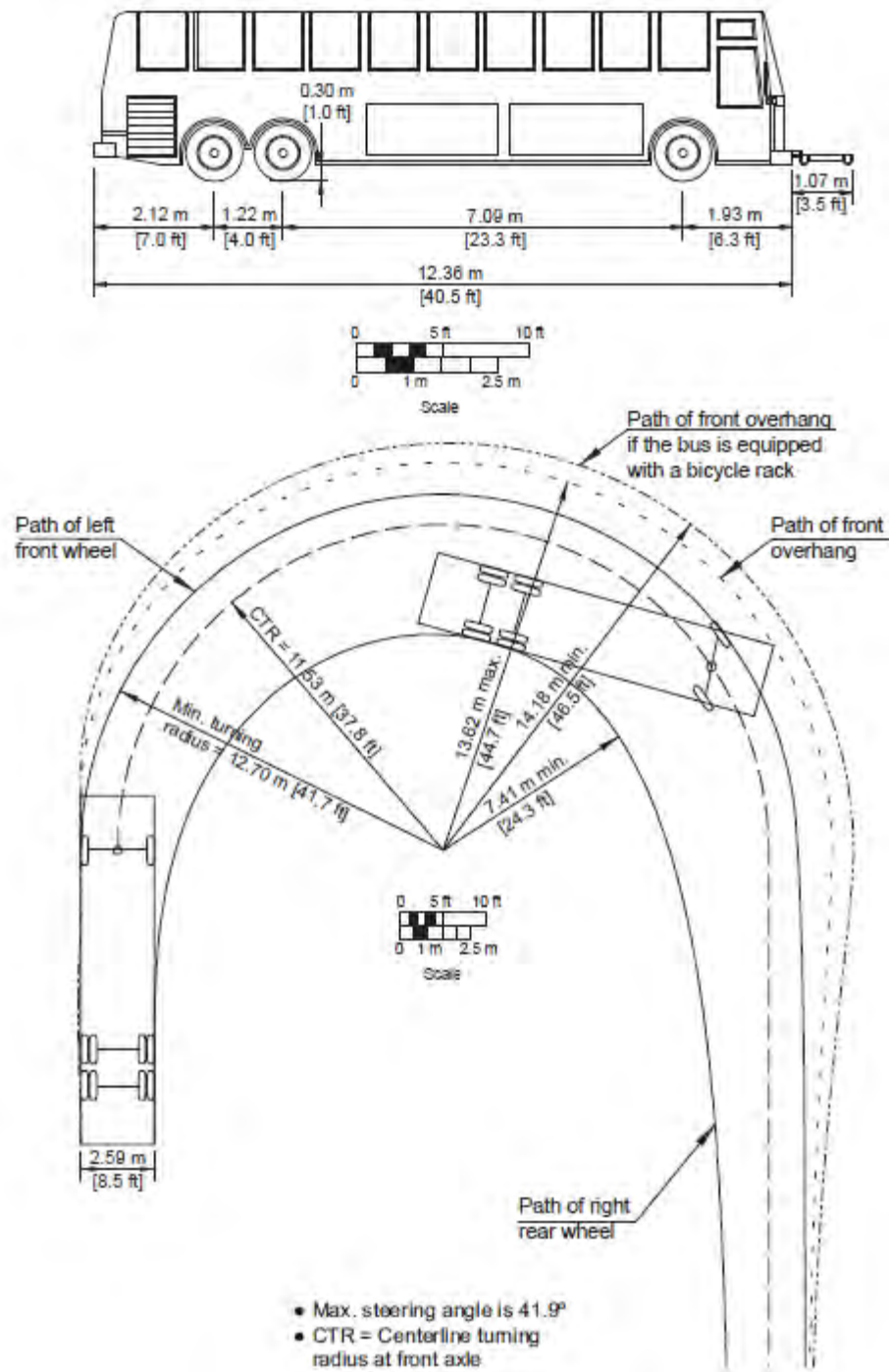

Figure 1.4 Minimum Turning Path for Intercity Bus (BUS-12 [BUS-40]) Design Vehicle

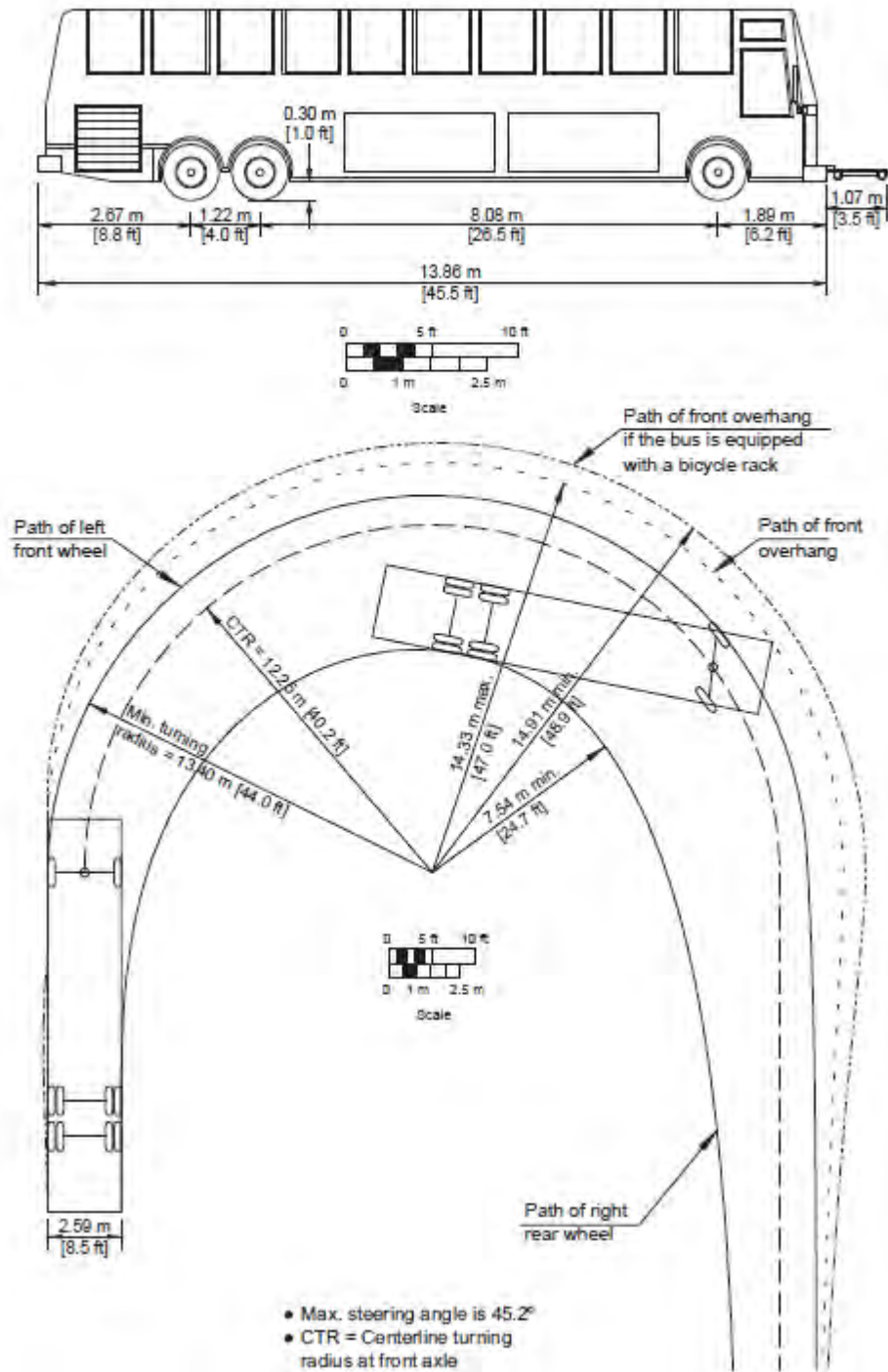

Figure 1.5 Minimum Turning Path for Intercity Bus (BUS-14 [BUS-45]) Design Vehicle

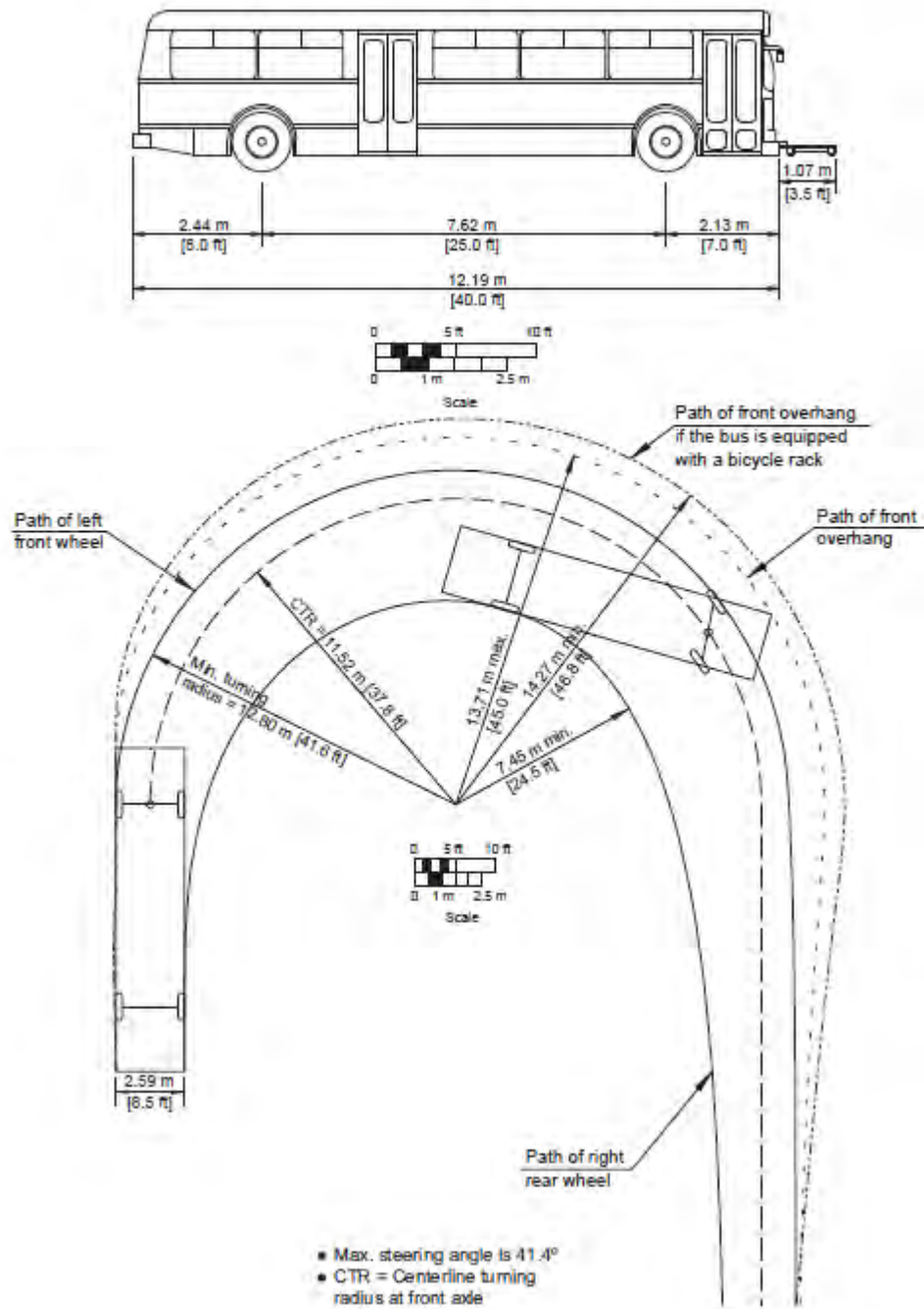

Figure 1.6 Minimum Turning Path for City Transit Bus (CITY-BUS) Design Vehicle

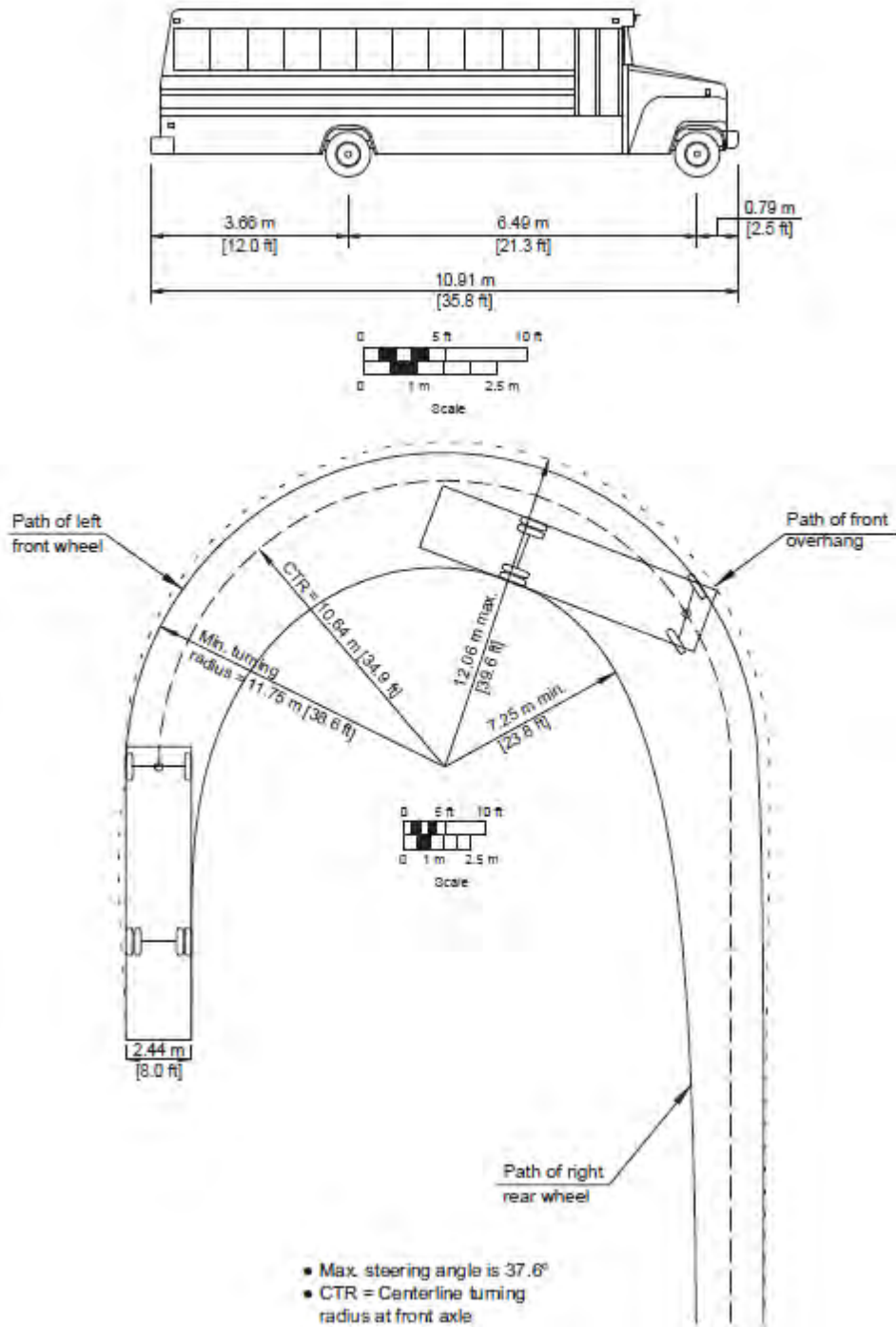

Figure 1.7 Minimum Turning Path for Conventional School Bus (S-BUS-11 [S-BUS-36]) Design Vehicle

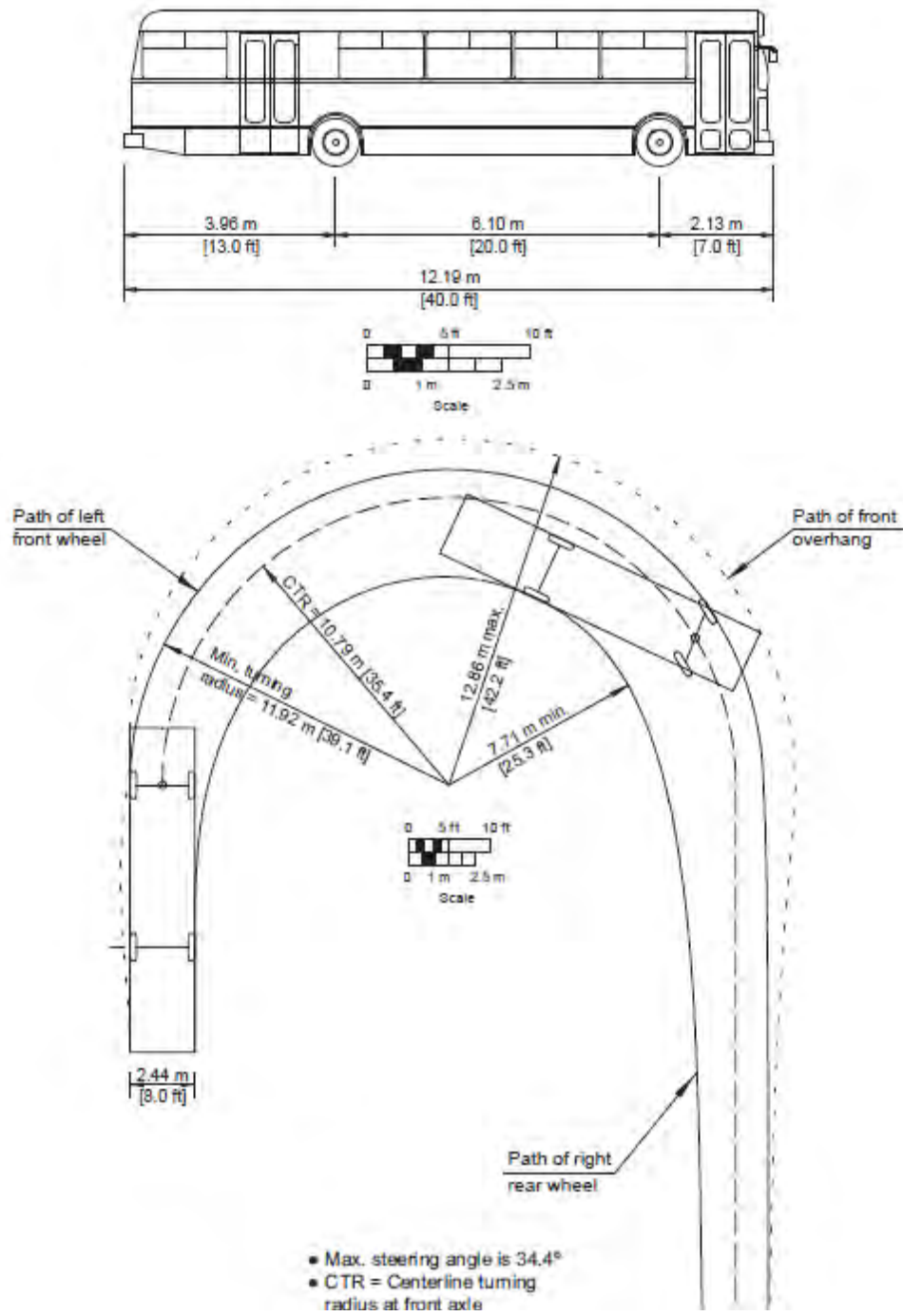

Figure 1.8 Minimum Turning Path for Large School Bus (S-BUS-12 [S-BUS-40]) Design Vehicle

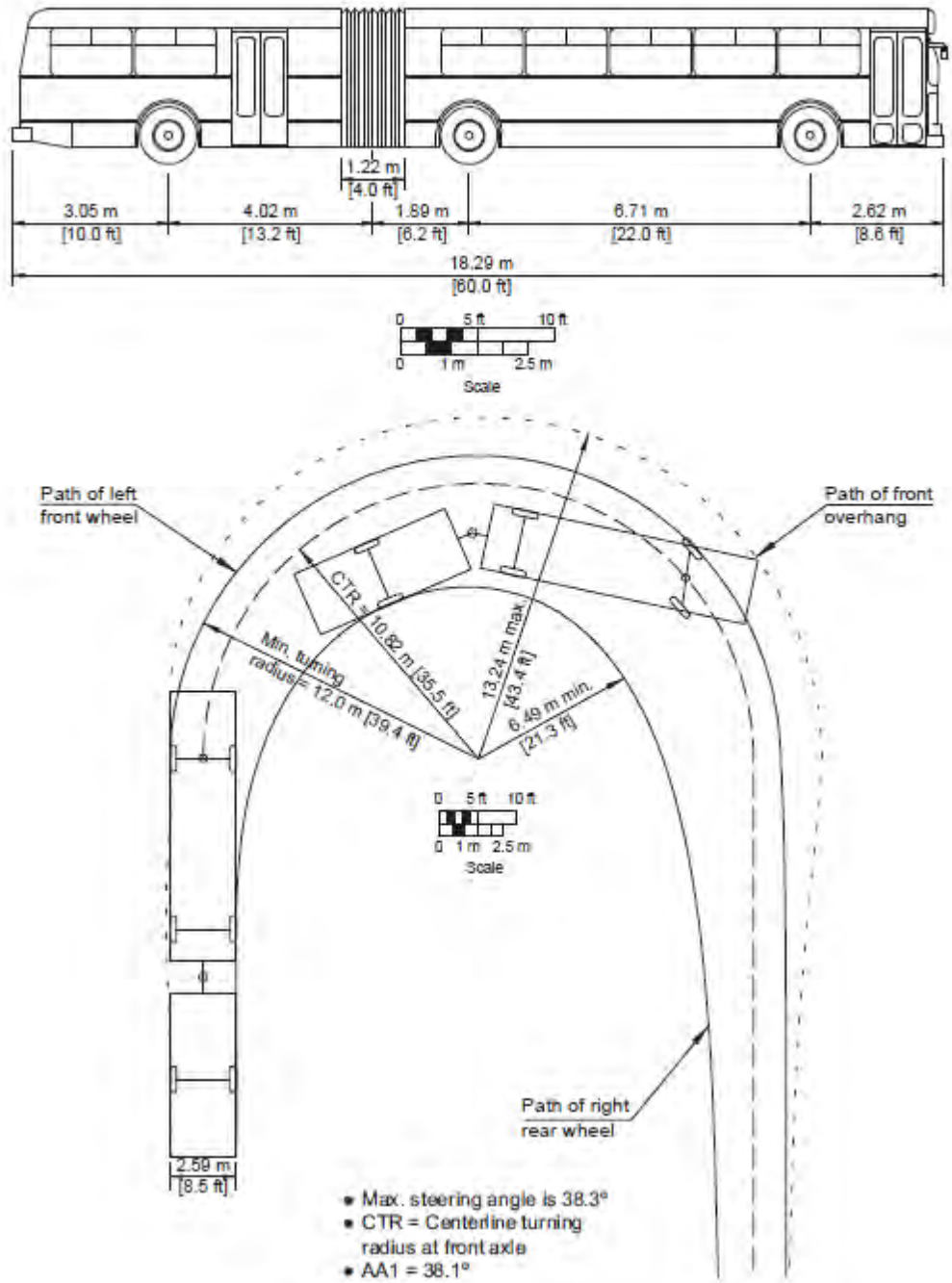

Figure 1.9 Minimum Turning Path for Articulated Bus (A-BUS) Design Vehicle

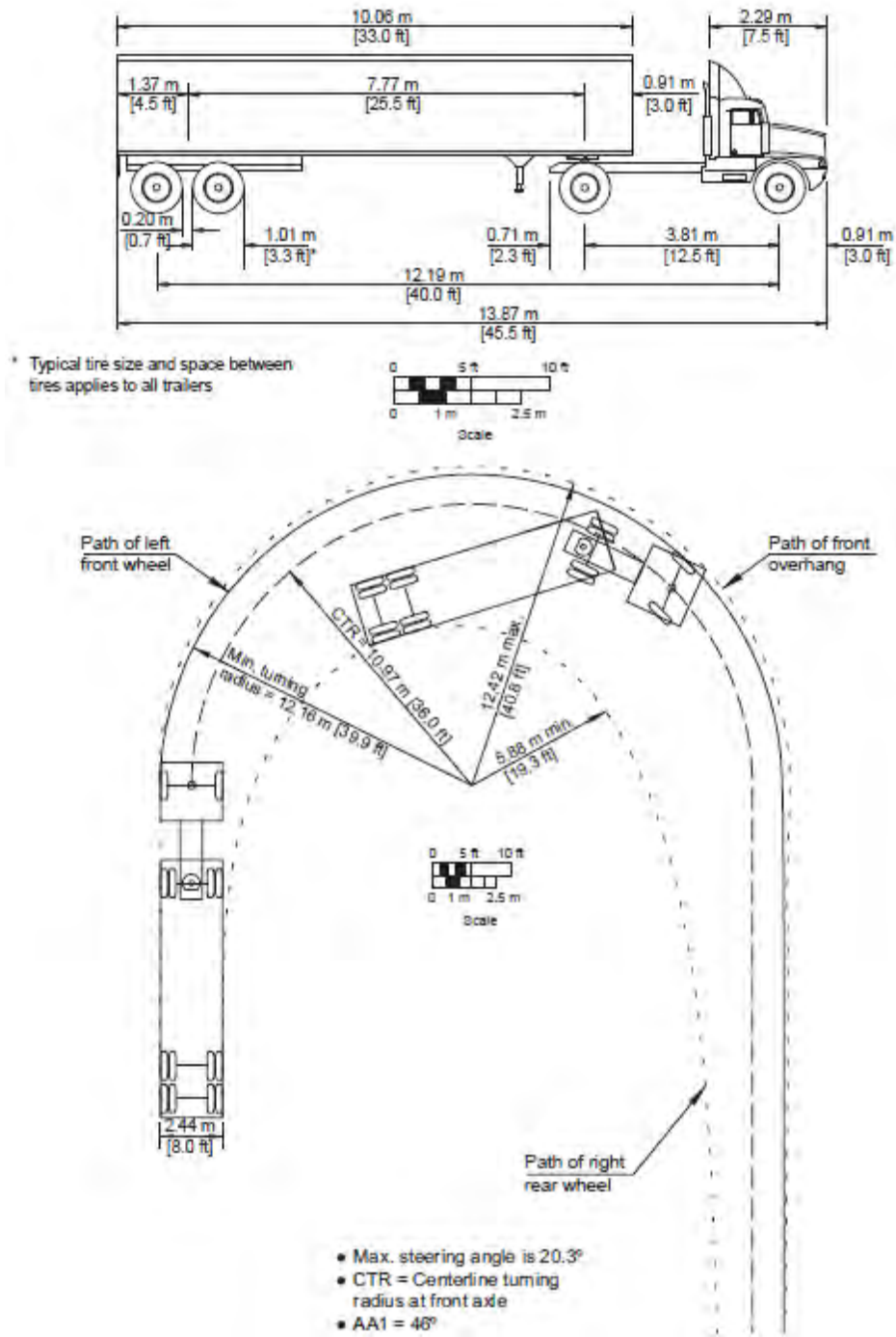

Figure 1.10 Minimum Turning Path for Intermediate Semitrailer (WB-12 [WB-40]) Design Vehicle

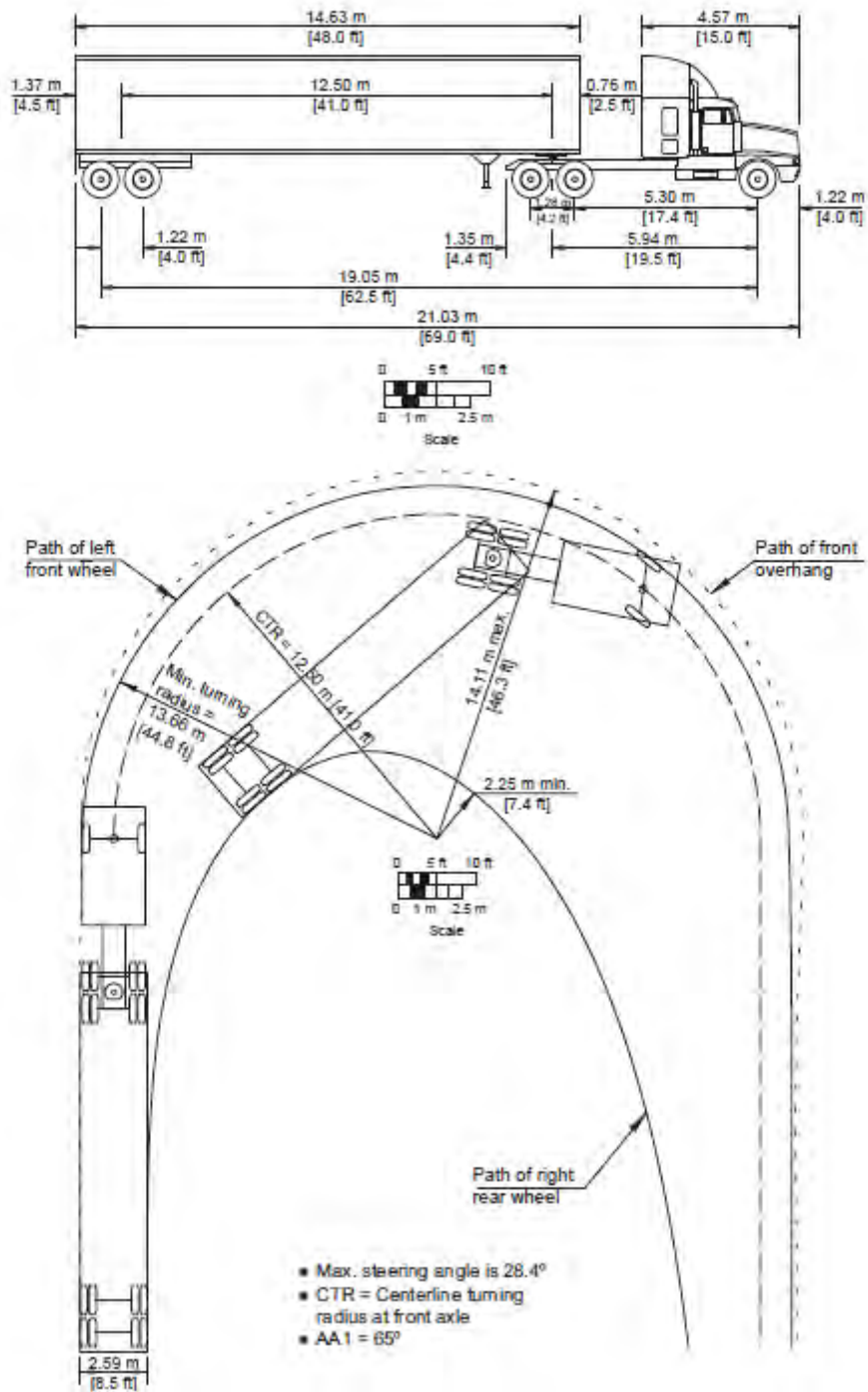

Figure 1.11 Minimum Turning Path for Interstate Semitrailer (WB-19 [WB-62]) Design Vehicle

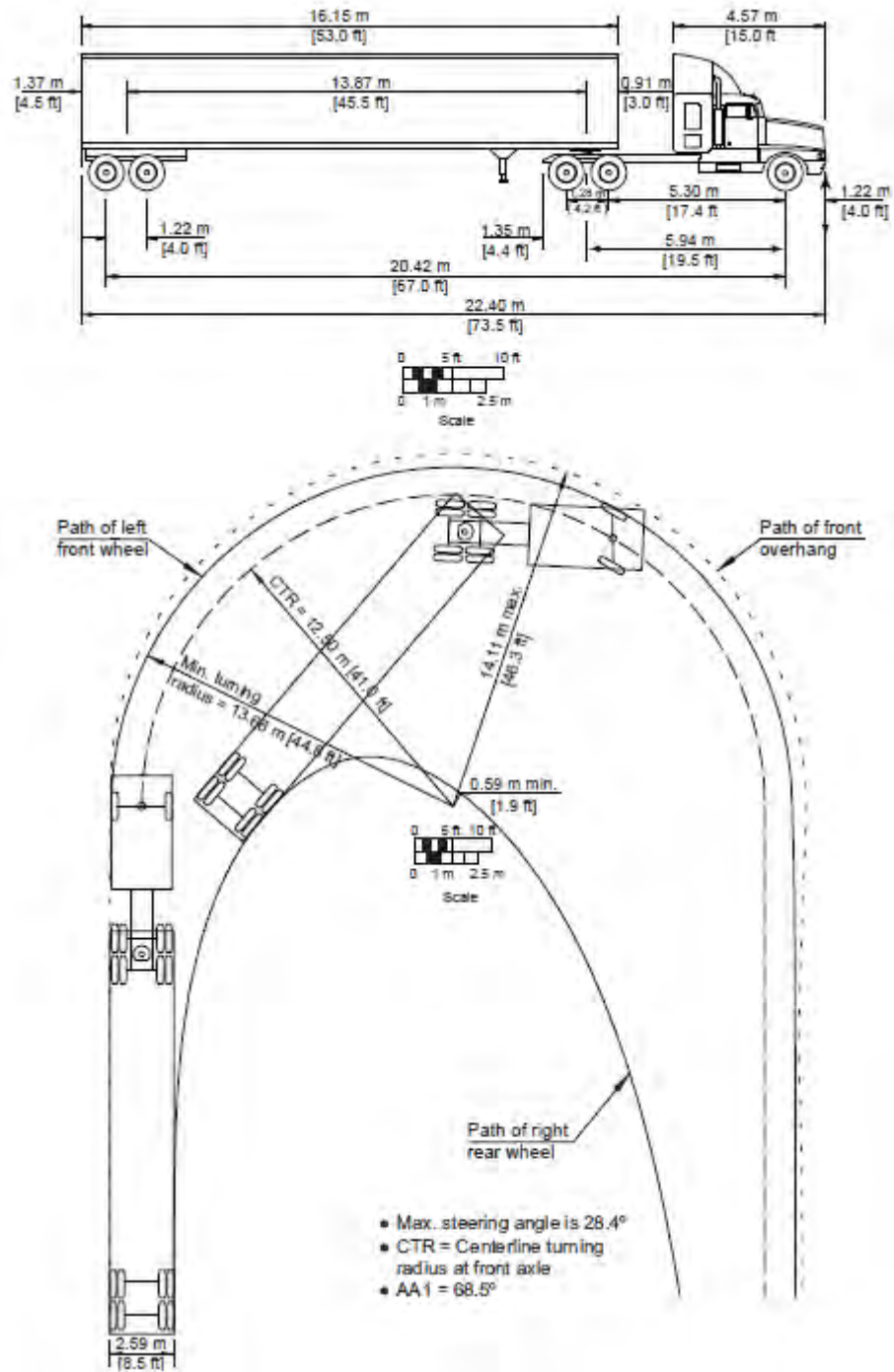

Figure 1.12 Minimum Turning Path for Interstate Semitrailer (WB-20 [WB-67]) Design Vehicle

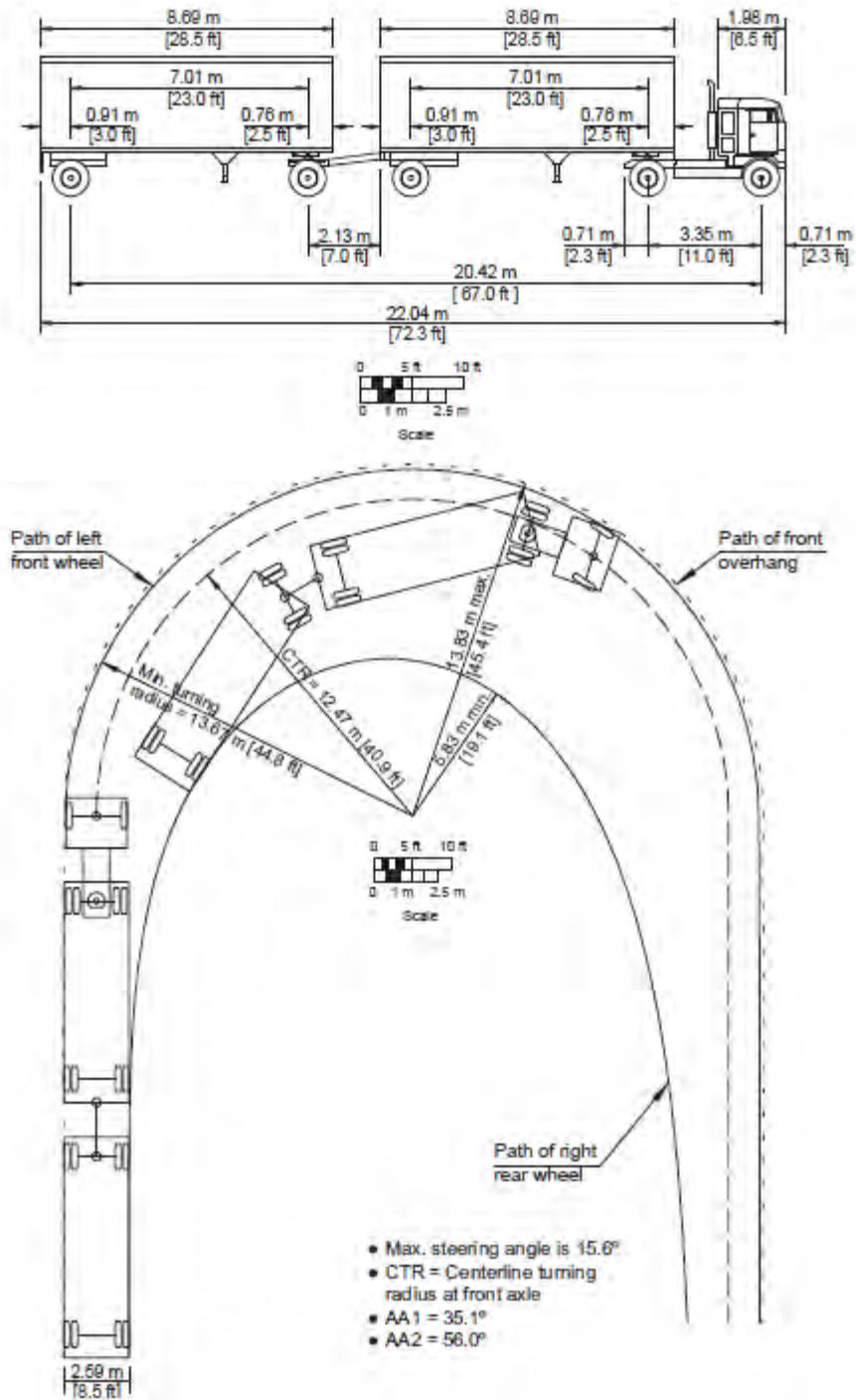

Figure 1.13 Minimum Turning Path for Double-Trailer Combination (WB-20D [WB-67D]) Design Vehicle

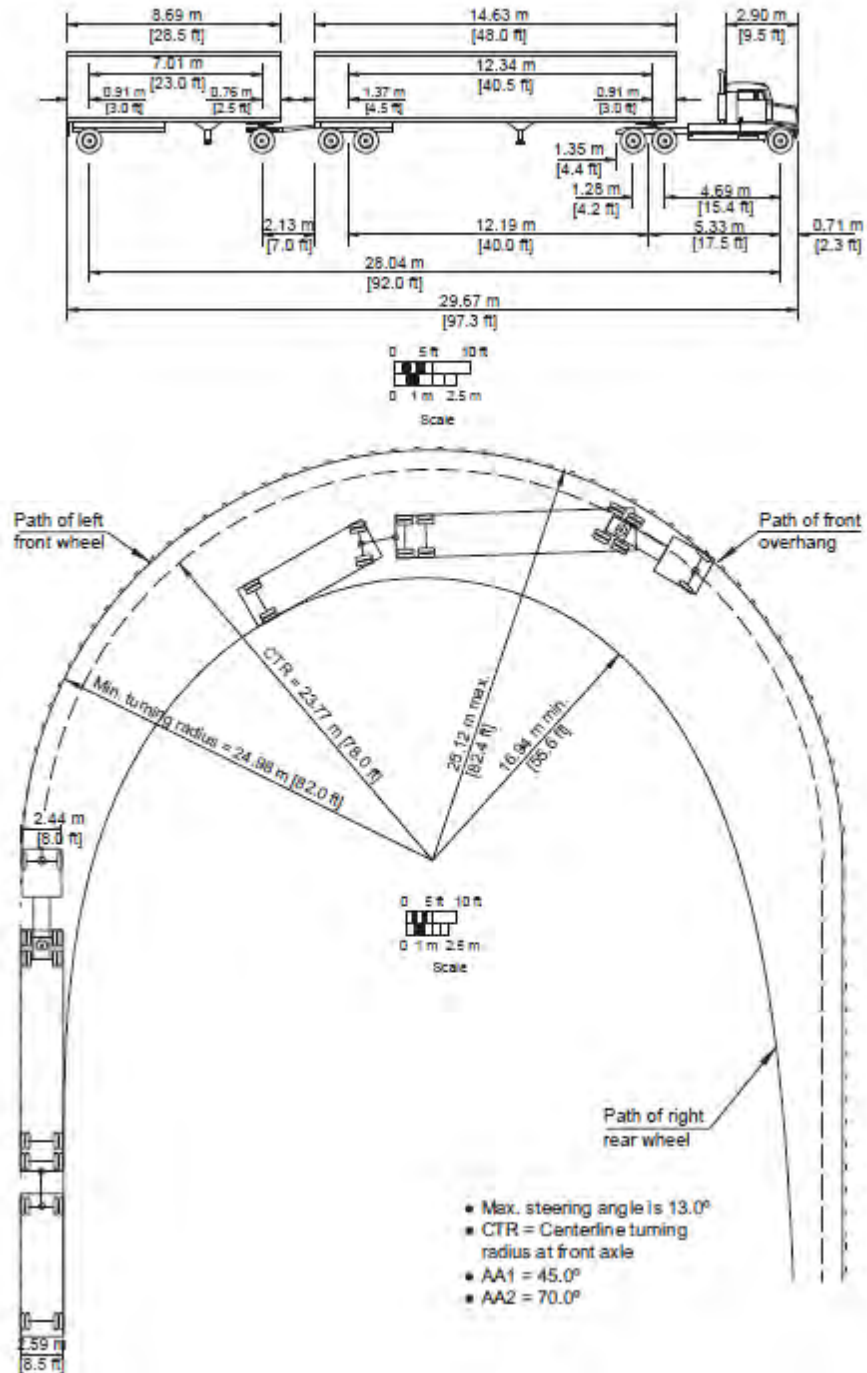

Figure 1.14 Minimum Turning Path for Rocky Mountain Double-Trailer Combination (WB-28D [WB-92D]) Design Vehicle

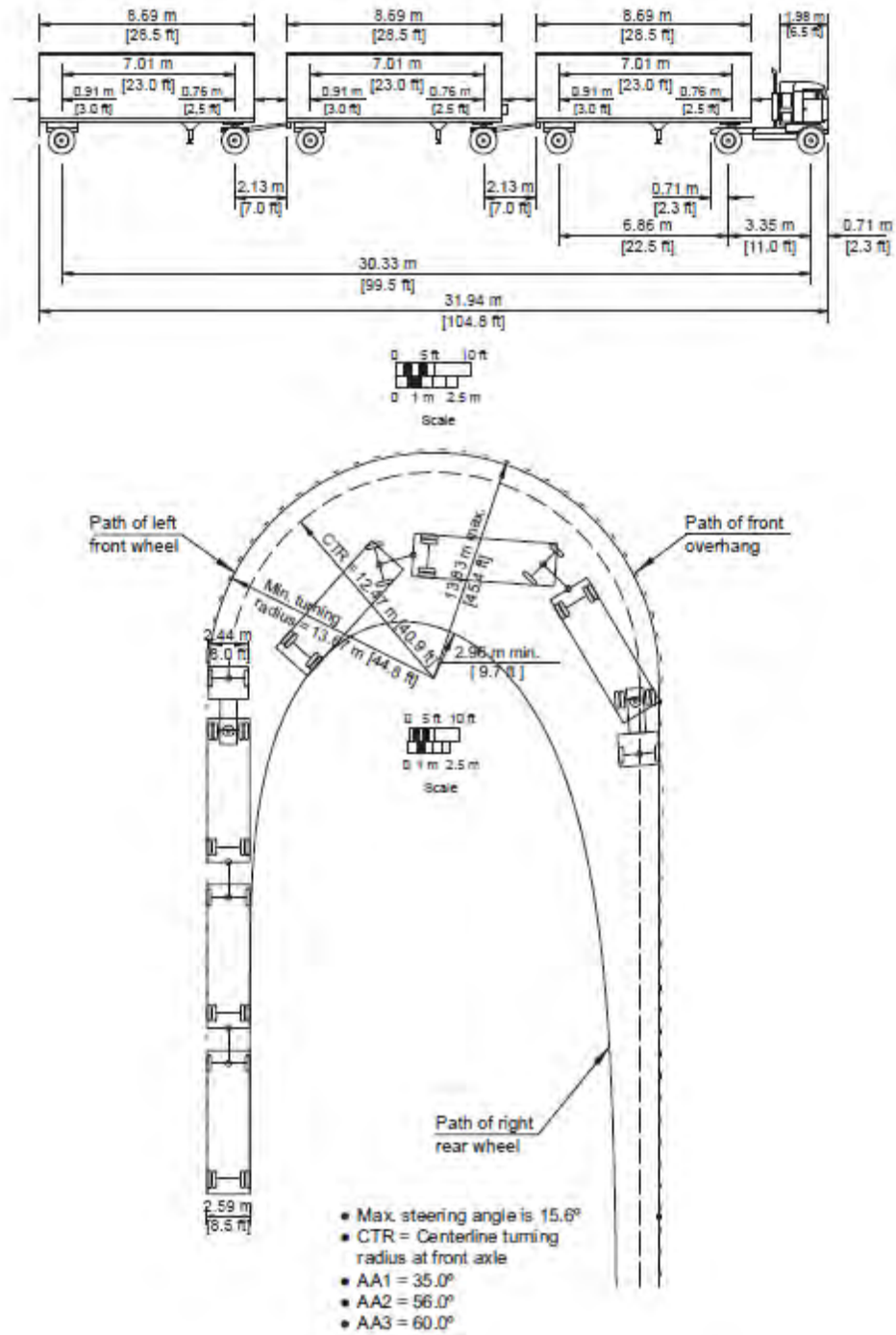

Figure 1.15 Minimum Turning Path for Triple-Trailer Combination (WB-30T [WB-100T]) Design Vehicle

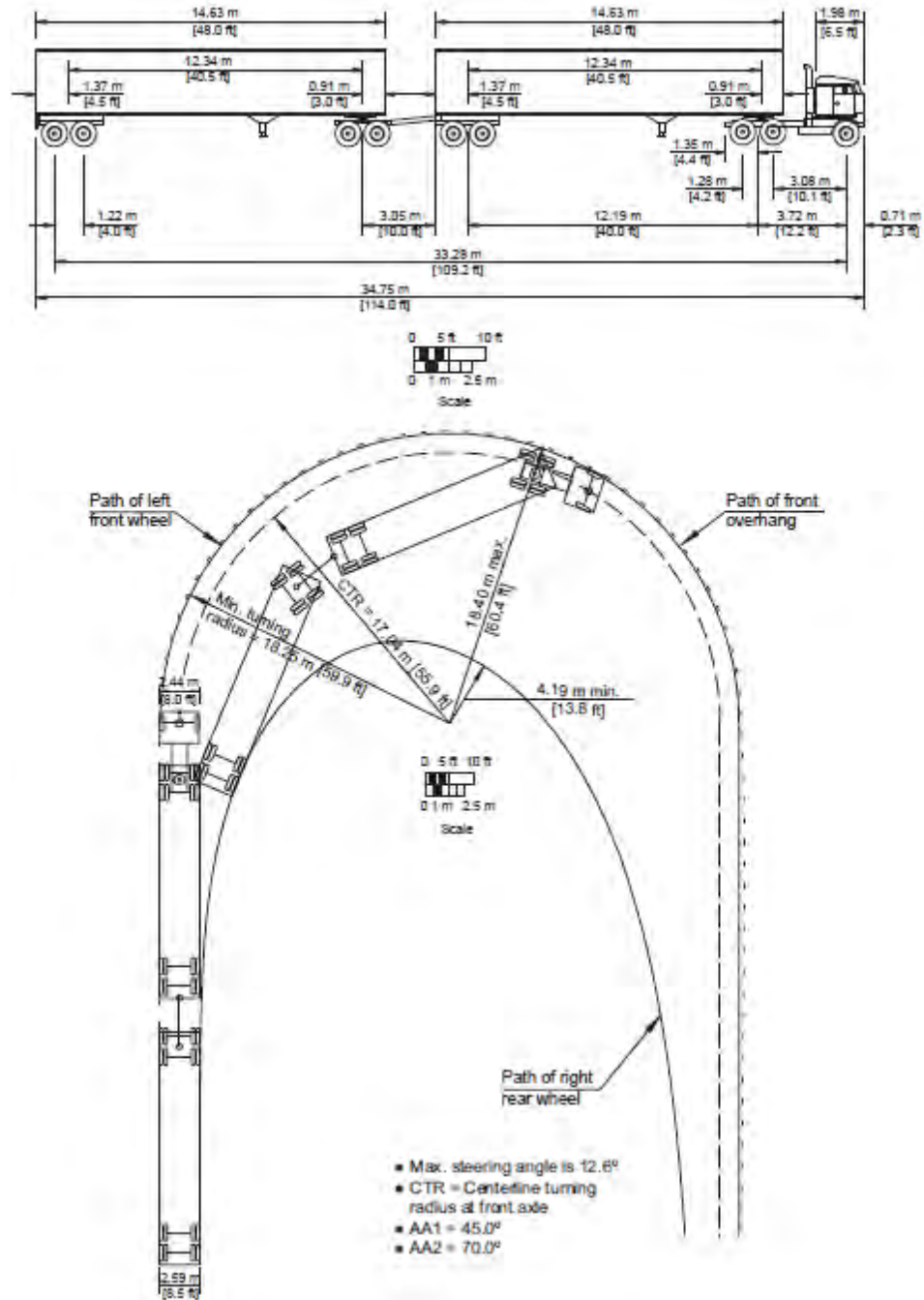

Figure 1.16 Minimum Turning Path for Turnpike-Double Combination (WB-33D [WB-109D]) Design Vehicle

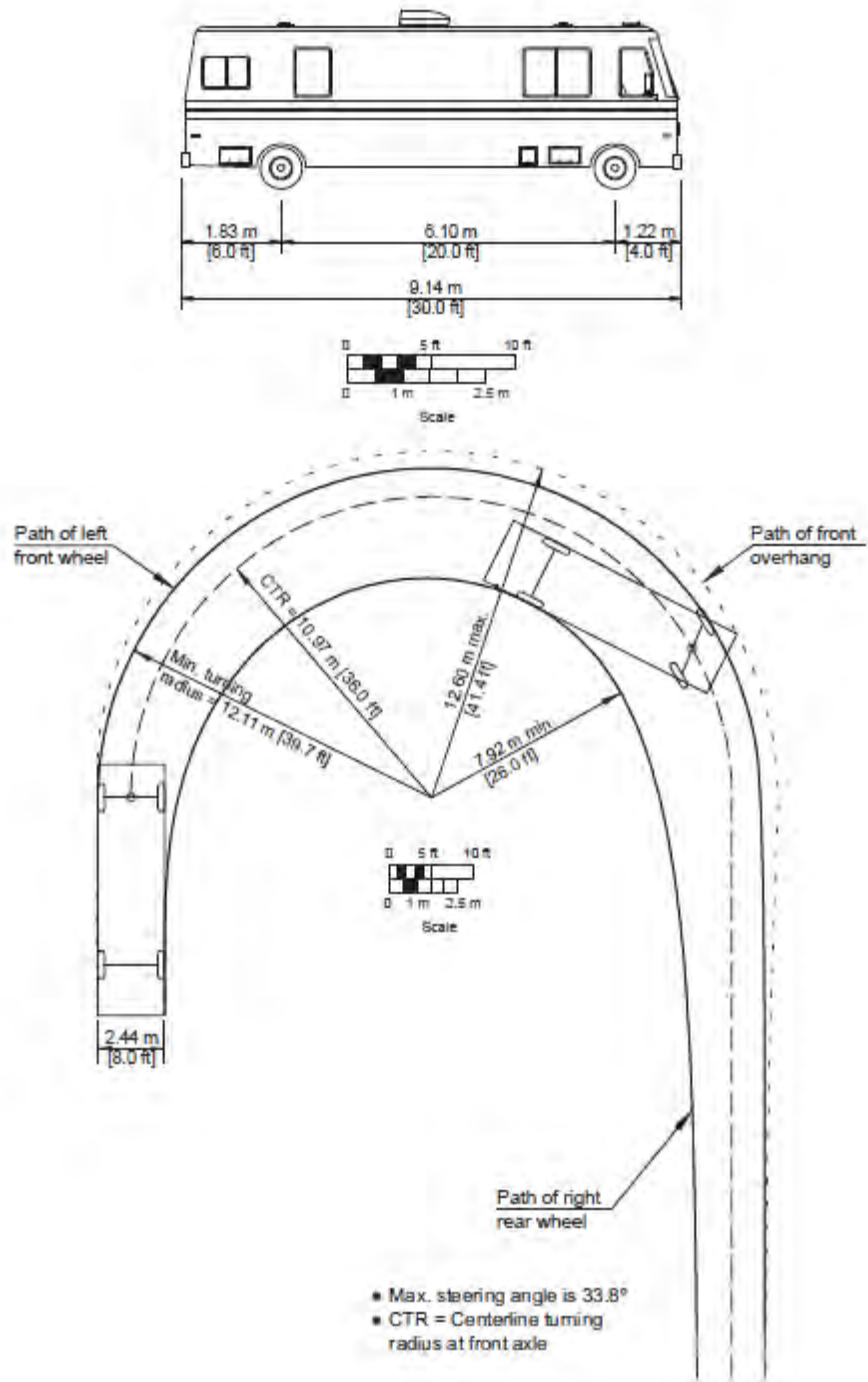

Figure 1.17 Minimum Turning Path for Motor Home (MH) Design Vehicle

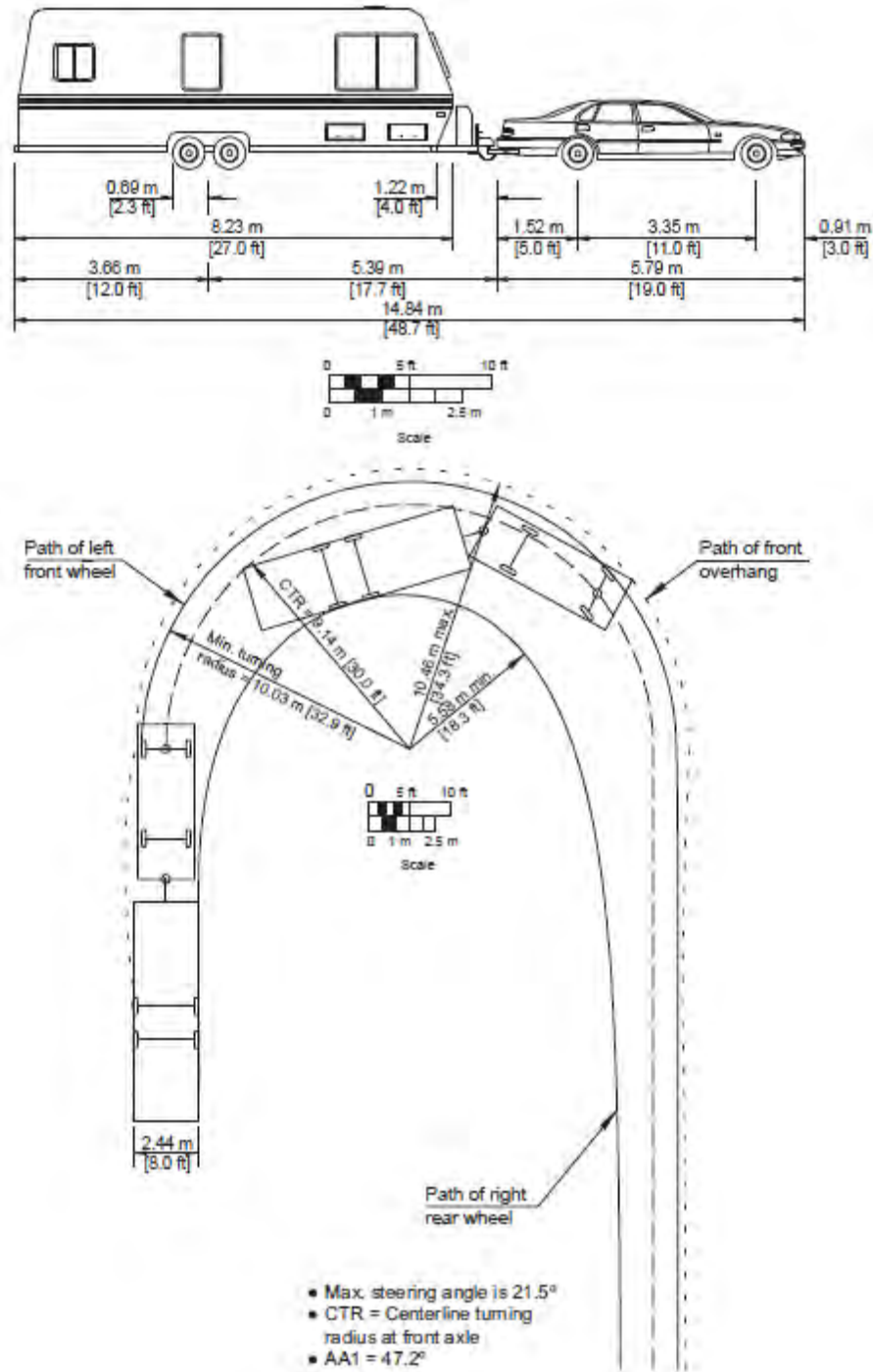

Figure 1.18 Minimum Turning Path for Passenger Car and Camper Trailer (P/T) Design Vehicle

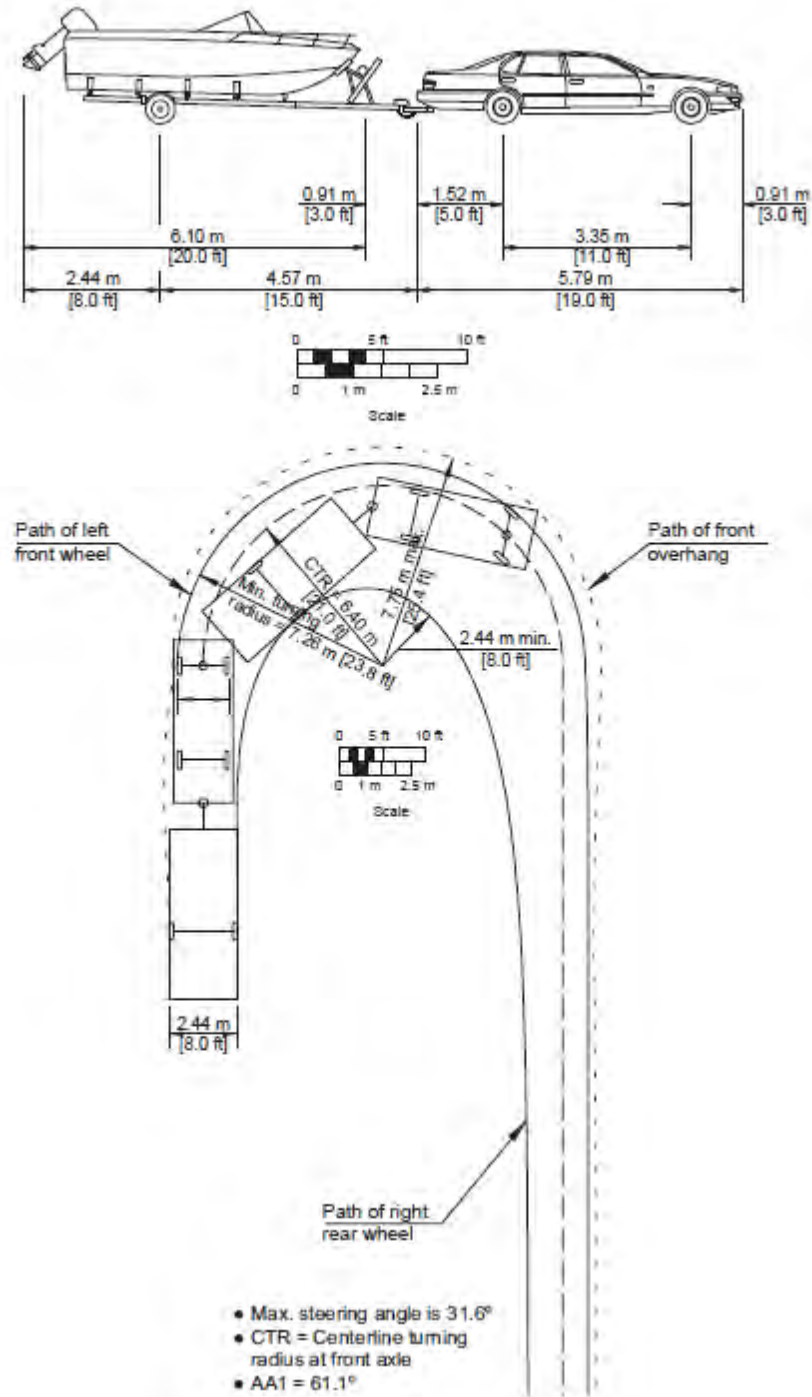

Figure 1.19 Minimum Turning Path for Passenger Car and Boat Trailer (P/B) Design Vehicle

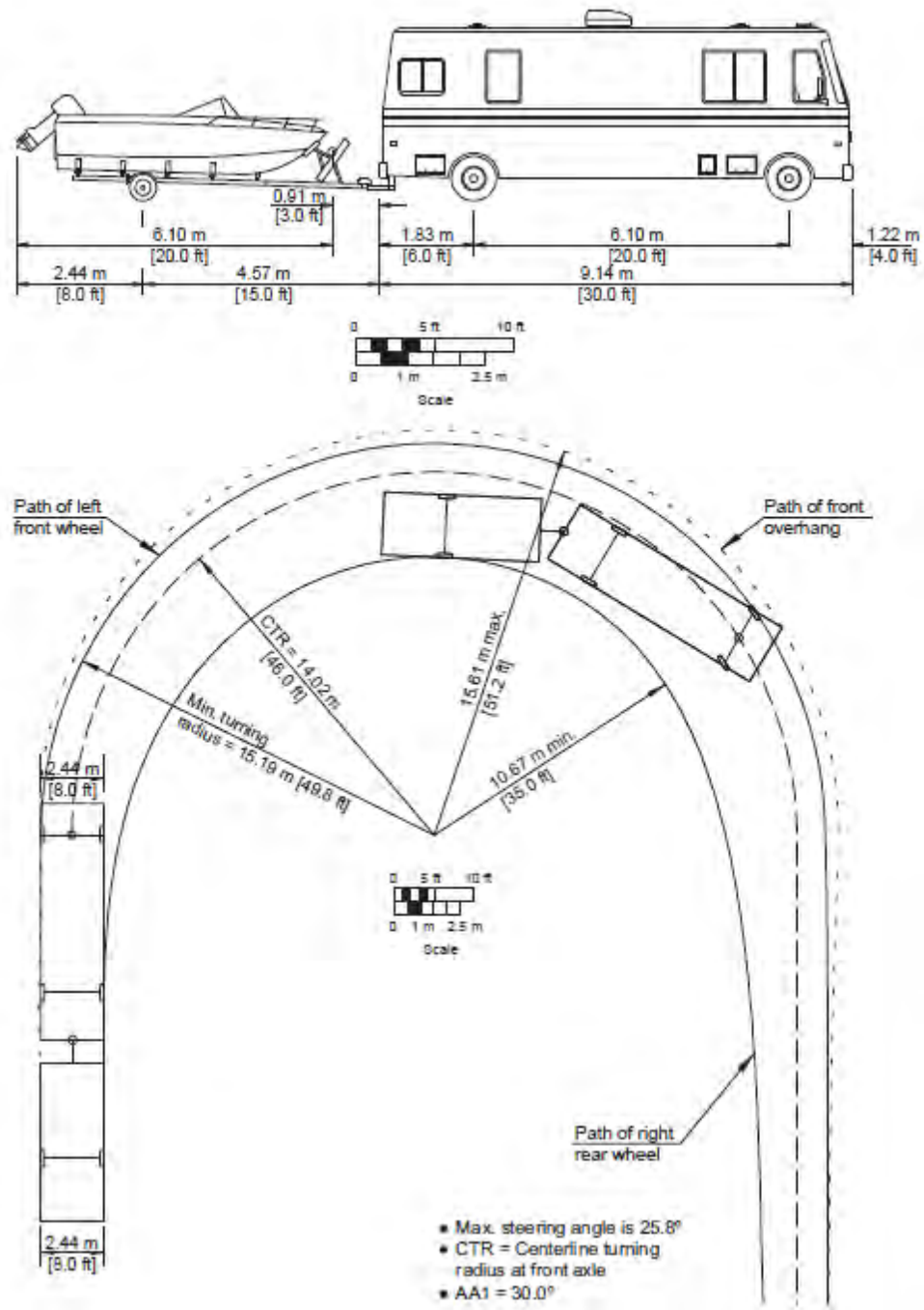

Figure 1.20 Minimum Turning Path for Motor Home and Boat Trailer (MH/B) Design Vehicle

2) Section 2 — Design Considerations

Sight Distance

This section provides descriptions and information on sight distance, one of several principal elements of design that are common to all types of highways and streets.

Sight distance is the length of roadway ahead that is visible to the driver. The available sight distance on a roadway should be sufficiently long to enable a vehicle traveling at or a near the design speed to stop before reaching a stationary object in its path. Although greater lengths of visible roadway are desirable, the sight distance at every point along a roadway should be at least that needed for a below-average driver or vehicle to stop.

Of utmost importance in highway design is the arrangement of geometric elements so that there is adequate sight distance for safe and efficient traffic operation assuming adequate light, clear atmospheric conditions, and drivers' visual acuity. For design, the following four types of sight distance are considered:

- **Stopping Sight Distance (SSD):** Stopping sight distance is the sum of two distances: (1) the distance traversed by the vehicle from the instant the driver sights an object necessitating a stop to the instant the brakes are applied; and (2) the distance needed to stop the vehicle from the instant brake application begins. These are referred to as brake reaction distance and braking distance, respectively. The stopping sight distance in feet is calculated using the equation below, where u_0 is in miles/hour, t is equal to 2.5 seconds, G is upgrade/downgrade in foot/foot, and a/g is equal to 0.35.

$$\text{Stopping Sight Distance} = 1.47u_0t + u_0^2/[30(a/g \pm G)]$$

The calculated and design stopping sight distances are shown in Table 2.1. The values given in Table 2.1 represent stopping sight distances on level terrain. As a general rule, the sight distance available on downgrades is larger than on upgrades, more or less automatically providing the necessary corrections for grade; therefore, corrections for the grade are usually unnecessary; however, Table 2.2 provides values for the stopping sight distance for upgrades and downgrades.

An example where correction for grade might come into play for stopping sight distance would be a divided roadway with independent design profiles in extreme rolling or mountainous terrain. AASHTO's A Policy on Geometric Design for Highways and Streets, provides additional information and suggested values for grade corrections in these rare circumstances.

Table 2.1 Stopping Sight Distance (Level Terrain)

| Metric | | | | | U.S. Customary | | | | |
|---------------------|-----------------------------|-------------------------------|-------------------------|------------|--------------------|------------------------------|--------------------------------|-------------------------|-------------|
| Design Speed (km/h) | Brake Reaction Distance (m) | Braking Distance on Level (m) | Stopping Sight Distance | | Design Speed (mph) | Brake Reaction Distance (ft) | Braking Distance on Level (ft) | Stopping Sight Distance | |
| | | | Calculated (m) | Design (m) | | | | Calculated (ft) | Design (ft) |
| 20 | 13.9 | 4.6 | 18.5 | 20 | 15 | 55.1 | 21.6 | 76.7 | 80 |
| 30 | 20.9 | 10.3 | 31.2 | 35 | 20 | 73.5 | 38.4 | 111.9 | 115 |
| 40 | 27.8 | 18.4 | 46.2 | 50 | 25 | 91.9 | 60.0 | 151.9 | 155 |
| 50 | 34.8 | 28.7 | 63.5 | 65 | 30 | 110.3 | 86.4 | 196.7 | 200 |
| 60 | 41.7 | 41.3 | 83.0 | 85 | 35 | 128.6 | 117.6 | 246.2 | 250 |
| 70 | 48.7 | 56.2 | 104.9 | 105 | 40 | 147.0 | 153.6 | 300.6 | 305 |
| 80 | 55.6 | 73.4 | 129.0 | 130 | 45 | 165.4 | 194.4 | 359.8 | 360 |
| 90 | 62.6 | 92.9 | 155.5 | 160 | 50 | 183.8 | 240.0 | 423.8 | 425 |
| 100 | 69.5 | 114.7 | 184.2 | 185 | 55 | 202.1 | 290.3 | 492.4 | 495 |
| 110 | 76.5 | 138.8 | 215.3 | 220 | 60 | 220.5 | 345.5 | 566.0 | 570 |
| 120 | 83.4 | 165.2 | 248.6 | 250 | 65 | 238.9 | 405.5 | 644.4 | 645 |
| 130 | 90.4 | 193.8 | 284.2 | 285 | 70 | 257.3 | 470.3 | 727.6 | 730 |
| | | | | | 75 | 275.6 | 539.9 | 815.5 | 820 |
| | | | | | 80 | 294.0 | 614.3 | 908.3 | 910 |

Note: Brake reaction distance predicated on a time of 2.5 s; deceleration rate of 3.4 m/s² [11.2 ft/s²] used to determine calculated sight distance.

Table 2.2 Stopping Sight Distance (Upgrades/Downgrades)

| Metric | | | | | | | U.S. Customary | | | | | | |
|---------------------|-----------------------------|-----|-----|----------|-----|-----|--------------------|------------------------------|------|------|----------|-----|-----|
| Design Speed (km/h) | Stopping Sight Distance (m) | | | | | | Design Speed (mph) | Stopping Sight Distance (ft) | | | | | |
| | Downgrades | | | Upgrades | | | | Downgrades | | | Upgrades | | |
| | 3 % | 6 % | 9 % | 3 % | 6 % | 9 % | | 3 % | 6 % | 9 % | 3 % | 6 % | 9 % |
| 20 | 20 | 20 | 20 | 19 | 18 | 18 | 15 | 80 | 82 | 85 | 75 | 74 | 73 |
| 30 | 32 | 35 | 35 | 31 | 30 | 29 | 20 | 116 | 120 | 126 | 109 | 107 | 104 |
| 40 | 50 | 50 | 53 | 45 | 44 | 43 | 25 | 158 | 165 | 173 | 147 | 143 | 140 |
| 50 | 66 | 70 | 74 | 61 | 59 | 58 | 30 | 205 | 215 | 227 | 200 | 184 | 179 |
| 60 | 87 | 92 | 97 | 80 | 77 | 75 | 35 | 257 | 271 | 287 | 237 | 229 | 222 |
| 70 | 110 | 116 | 124 | 100 | 97 | 93 | 40 | 315 | 333 | 354 | 289 | 278 | 269 |
| 80 | 136 | 144 | 154 | 123 | 118 | 114 | 45 | 378 | 400 | 427 | 344 | 331 | 320 |
| 90 | 164 | 174 | 187 | 148 | 141 | 136 | 50 | 446 | 474 | 507 | 405 | 388 | 375 |
| 100 | 194 | 207 | 223 | 174 | 167 | 160 | 55 | 520 | 553 | 593 | 469 | 450 | 433 |
| 110 | 227 | 243 | 262 | 203 | 194 | 186 | 60 | 598 | 638 | 686 | 538 | 515 | 495 |
| 120 | 263 | 281 | 304 | 234 | 223 | 214 | 65 | 682 | 728 | 785 | 612 | 584 | 561 |
| 130 | 302 | 323 | 350 | 267 | 254 | 243 | 70 | 771 | 825 | 891 | 690 | 658 | 631 |
| | | | | | | | 75 | 866 | 927 | 1003 | 772 | 736 | 704 |
| | | | | | | | 80 | 965 | 1035 | 1121 | 859 | 817 | 782 |

Note: Brake reaction distance predicated on a time of 2.5 s; deceleration rate of 3.4 m/s² [11.2 ft/s²]

- Decision Sight Distance:** Decision sight distance is the distance required for a driver to detect an unexpected or otherwise difficult-to-perceive information source, recognize the source, select an appropriate speed and path, and initiate and complete the required maneuver safely and efficiently. Because decision sight distance gives drivers additional margin for error and affords them sufficient length to maneuver their vehicles at the same or reduced speed rather than to just stop; its values are substantially greater than stopping sight distance. Table 2.3 shows recommended decision sight distance values for various avoidance maneuvers.

Table 2.3 Recommended Decision Sight Distance Values

| Metric | | | | | | U.S. Customary | | | | | |
|---------------------|-----------------------------|-----|-----|-----|-----|--------------------|------------------------------|------|------|------|------|
| Design Speed (km/h) | Decision Sight Distance (m) | | | | | Design Speed (mph) | Decision Sight Distance (ft) | | | | |
| | Avoidance Maneuver | | | | | | Avoidance Maneuver | | | | |
| | A | B | C | D | E | | A | B | C | D | E |
| 50 | 70 | 155 | 145 | 170 | 195 | 30 | 220 | 490 | 450 | 535 | 620 |
| 60 | 95 | 195 | 170 | 205 | 235 | 35 | 275 | 590 | 525 | 625 | 720 |
| 70 | 115 | 235 | 200 | 235 | 275 | 40 | 330 | 690 | 600 | 715 | 825 |
| 80 | 140 | 280 | 230 | 270 | 315 | 45 | 395 | 800 | 675 | 800 | 930 |
| 90 | 170 | 325 | 270 | 315 | 360 | 50 | 465 | 910 | 750 | 890 | 1030 |
| 100 | 200 | 370 | 315 | 355 | 400 | 55 | 535 | 1030 | 865 | 980 | 1135 |
| 110 | 235 | 420 | 330 | 380 | 430 | 60 | 610 | 1150 | 990 | 1125 | 1280 |
| 120 | 265 | 470 | 360 | 415 | 470 | 65 | 695 | 1275 | 1050 | 1220 | 1365 |
| 130 | 305 | 525 | 390 | 450 | 510 | 70 | 780 | 1410 | 1105 | 1275 | 1445 |
| | | | | | | 75 | 875 | 1545 | 1180 | 1365 | 1545 |
| | | | | | | 80 | 970 | 1685 | 1260 | 1455 | 1650 |

Avoidance Maneuver A: Stop on rural road— $t = 3.0$ s

Avoidance Maneuver B: Stop on urban road— $t = 9.1$ s

Avoidance Maneuver C: Speed/path/direction change on rural road— t varies between 10.2 and 11.2 s

Avoidance Maneuver D: Speed/path/direction change on suburban road— t varies between 12.1 and 12.9 s

Avoidance Maneuver E: Speed/path/direction change on urban road— t varies between 14.0 and 14.5 s

- Passing Sight Distance (PSD):** The passing sight distance is the minimum sight distance required on a two-lane, two-way highway that will permit a driver to complete a passing maneuver without colliding with an opposing vehicle and without cutting off the passed vehicle. The passing sight distance will also allow the driver to successfully abort the passing maneuver (that is, return to the right lane behind the vehicle being passed) if he or she so desires.

In determining minimum passing sight distances for design purposes, only single passes (that is, a single vehicle passing a single vehicle) are considered. Although it is possible for multiple passing maneuvers to occur (that is, more than one vehicle pass or are passed in one maneuver), it is not practical for minimum design criteria to be based on them.

In order to determine the minimum passing sight distance, certain assumptions have to be made regarding the movement of the passing vehicle during a passing maneuver:

1. The vehicle being passed (impeder) is traveling at a uniform speed.
2. The speed of the passing vehicle is reduced and is behind the impeder as the passing section is entered.
3. On arrival at a passing section, some time elapses during which the driver decides whether to undertake the passing maneuver.
4. If the decision is made to pass, the passing vehicle is accelerated during the passing maneuver, and the average passing speed is about 10 mi/h more than the speed of the impeder vehicle.
5. A suitable clearance exists between the passing vehicle and any opposing vehicle when the passing vehicle reenters the right lane.

These assumptions have been used by AASHTO to develop a minimum passing sight distance requirement for two-lane, two-way highways.

The minimum passing sight distance is the total of four components as shown in Figure 2.1, where:

d₁: is the distance in feet that is traversed during perception-reaction time and during initial acceleration to the point where the passing vehicle just enters the left lane.

$$d_1 = (1.47)(t_1)(u - m + at_1/2)$$

where:

t₁ = time for initial maneuver in seconds

a = average acceleration rate in mi/hr/sec

u = average speed of passing vehicle in mi/hr

m = difference in speeds of passing and impeder vehicles

d₂: is the distance in feet traveled during the time the passing vehicle is traveling in the left lane.

$$d_2 = (1.47)(u)(t_2)$$

where:

t_2 = time passing vehicle is traveling in left lane in seconds

u = average speed of passing vehicle in mi/hr

d_3 : is the distance between the passing vehicle and the opposing vehicle at the end of the passing maneuver and has been found to vary between 100 ft and 300 ft.

d_4 : is the distance moved by the opposing vehicle during two thirds of the time the passing vehicle is in the left lane (usually taken to be $2/3 d_2$).

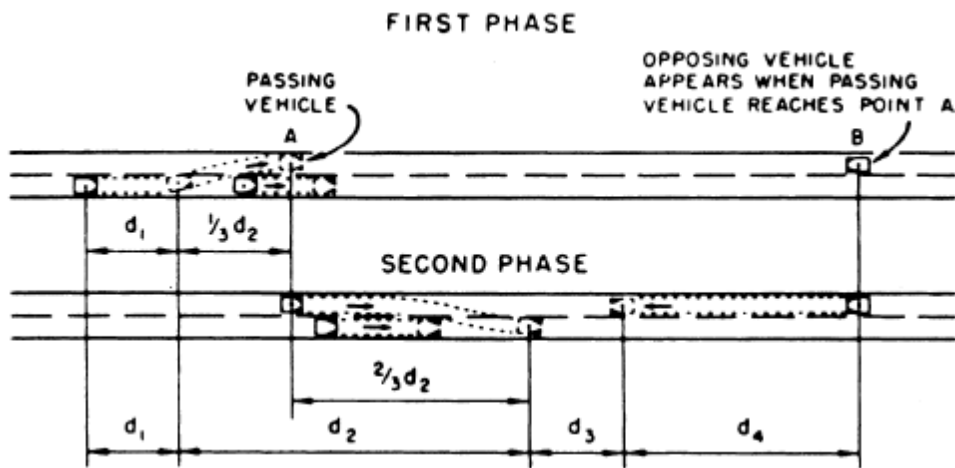

Figure 2.1 Elements of and Total Passing Sight Distance on Two-Lane Highways

Table 2.4 shows these components calculated for different speeds. It should be made clear that values given in Table 2.4 are for design purposes and cannot be used for marking passing and no-passing zones on completed highways. The values used for that purpose are obtained from different assumptions and are much shorter.

Table 2.4 Components of Safe Passing Sight Distance on Two-Lane Highways

| Metric | | | | U.S. Customary | | | |
|---------------------|-----------------------|-----------------|----------------------------|--------------------|----------------------|-----------------|-----------------------------|
| Design Speed (km/h) | Assumed Speeds (km/h) | | Passing Sight Distance (m) | Design Speed (mph) | Assumed Speeds (mph) | | Passing Sight Distance (ft) |
| | Passed Vehicle | Passing Vehicle | | | Passed Vehicle | Passing Vehicle | |
| 30 | 11 | 30 | 120 | 20 | 8 | 20 | 400 |
| 40 | 21 | 40 | 140 | 25 | 13 | 25 | 450 |
| 50 | 31 | 50 | 160 | 30 | 18 | 30 | 500 |
| 60 | 41 | 60 | 180 | 35 | 23 | 35 | 550 |
| 70 | 51 | 70 | 210 | 40 | 28 | 40 | 600 |
| 80 | 61 | 80 | 245 | 45 | 33 | 45 | 700 |
| 90 | 71 | 90 | 280 | 50 | 38 | 50 | 800 |
| 100 | 81 | 100 | 320 | 55 | 43 | 55 | 900 |
| 110 | 91 | 110 | 355 | 60 | 48 | 60 | 1000 |
| 120 | 101 | 120 | 395 | 65 | 53 | 65 | 1100 |
| 130 | 111 | 130 | 440 | 70 | 58 | 70 | 1200 |
| | | | | 75 | 63 | 75 | 1300 |
| | | | | 80 | 68 | 80 | 1400 |

- **Intersection Sight Distance:** The operator of a vehicle approaching an intersection should have an unobstructed view of the entire intersection and an adequate view of the intersecting highway to permit control of the vehicle to avoid a collision. When designing an intersection, the following factors should be taken into consideration:
 1. Adequate sight distance should be provided along both highway approaches and across corners.
 2. Gradients of intersecting highways should be as flat as practical on sections that are to be used for storage of stopped vehicles.
 3. Combination of vertical and horizontal curvature should allow adequate sight distance of the intersection.
 4. Traffic lanes and marked pedestrian crosswalks should be clearly visible at all times.
 5. Lane markings and signs should be clearly visible and understandable from a desired distance.
 6. Intersections should eliminate, relocate or modify conflict points to the extent allowable in order to improve safety.
 7. Intersections should be evaluated for the effects of barriers, rails, and retaining walls on sight distance.

For selecting intersection sight distance, refer to AASHTO's A Policy on Geometric Design for Highways and Streets. Sight distance criteria are provided for the following types of intersection controls:

1. Intersections with no control.
2. Intersections with stop control on the minor road.
3. Intersections with yield control on the minor road.
4. Intersections with traffic signal control.
5. Intersections with all-way stop control.
6. Left turns from the major road.

Lanes

The lanes are parts of the roads that are designated to be used by a single line of vehicles to control and guide drivers and reduce traffic conflicts. The lane width of a roadway influences the comfort of driving, operational characteristics, and, in some situations, the likelihood of crashes. Lane widths of 2.7 to 3.6 m [9 to 12 ft] are generally used, with a 3.6-m [12-ft] lane predominant on most high-speed, high-volume highways. The extra cost of providing a 3.6-m [12-ft] lane width, over the cost of providing a 3.0-m [10-ft] lane width is offset to some extent by a reduction in cost of shoulder maintenance and a reduction in surface maintenance due to lessened wheel concentrations at the pavement edges. The wider 3.6-m [12-ft] lane provides desirable clearances between large commercial vehicles traveling in opposite directions on two-lane, two-way rural highways when high traffic volumes and particularly high percentages of commercial vehicles are expected.

Lane widths also affect highway level of service. Narrow lanes force drivers to operate their vehicles closer to each other laterally than they would normally desire. Restricted clearances have a similar effect. In a capacity sense, the effective width of traveled way is reduced by adjacent obstructions such as retaining walls, bridge trusses or headwalls, and parked cars that restrict the lateral clearance. Where unequal-width lanes are used, locating the wider lane on the outside (right) provides more space for large vehicles that usually occupy that lane, provides more space for bicycles, and allows drivers to keep their vehicles at a greater distance from the right edge. Where a curb is used adjacent to only one edge, the wider lane should be placed adjacent to that curb. The basic design decision is the total roadway width, while the placement of stripes actually determines the lane widths.

In urban areas where pedestrian crossings, right-of-way, or existing development become stringent controls on lane widths, the use of 3.3-m [11-ft] lanes may be appropriate. Lanes 3.0 m [10 ft] wide are acceptable on low-speed facilities, and lanes 2.7 m [9 ft] wide may be appropriate on low-volume roads in rural and residential areas. In some instances, on multilane facilities in urban areas, narrower inside lanes may be utilized to permit wider outside lanes for bicycle use.

Auxiliary lanes at intersections and interchanges often help to facilitate traffic movements. Such added lanes should be as wide as the through-traffic lanes but not less than 3.0 m [10 ft]. Where continuous two-way left-turn lanes are provided, a lane width of 3.0 m to 4.8 m [10 to 16 ft] provides the optimum design.

It may not be cost-effective to design the lane and shoulder widths of local and collector roads and streets that carry less than 400 vehicles per day using the same criteria applicable to higher volume roads or to make extensive operational and safety improvements to such very low-volume roads. Alternative design criteria may be considered for local and collector roads and streets that carry less than 400 vehicles per day in accordance with the AASHTO Guidelines for Geometric Design of Very Low-Volume Local Roads ($ADT \leq 400$).

Shoulders

A shoulder is the portion of the roadway contiguous with the traveled way that accommodates stopped vehicles, emergency use, and lateral support of subbase, base, and surface courses.

Shoulders may be surfaced either full or partial width to provide a better all-weather load support than that afforded by native soils. Materials used to surface shoulders include gravel, shell, crushed rock, mineral or chemical additives, bituminous surface treatments, and various forms of asphaltic or concrete pavements.

Desirably, a vehicle stopped on the shoulder should clear the edge of the traveled way by at least 0.3 m [1 ft], and preferably by 0.6 m [2 ft]. These dimensions have led to the adoption of 3.0 m [10 ft] as the normal shoulder width that is preferred along higher speed, higher volume facilities. In difficult terrain and on low-volume highways, shoulders of this width may not be practical. A minimum shoulder width of 0.6 m [2 ft] should be considered for low-volume highways, and a 1.8- to 2.4-m [6- to 8-ft] shoulder width is preferable. Heavily traveled, high-speed highways and highways carrying large numbers of trucks should have usable shoulders at least 3.0 m [10 ft] wide and preferably 3.6 m [12 ft] wide; however, widths greater than 3.0 m [10 ft] may encourage unauthorized use of the shoulder as a travel lane. Where bicyclists and pedestrians are to be accommodated on the shoulders, a minimum usable shoulder width (i.e., clear of rumble strips) of 1.2 m [4 ft] should be considered.

Where roadside barriers, walls, or other vertical elements are present, it is desirable to provide a graded shoulder wide enough that the vertical elements will be offset a minimum of 0.6 m [2 ft] from the outer edge of the usable shoulder. To provide lateral support for guardrail posts or clear space for lateral dynamic deflection of the particular barrier in use, or both, it may be appropriate to provide a graded shoulder that is wider than the shoulder where no vertical elements are present. On low-volume roads, roadside barriers may be placed at the outer edge of the shoulder; however, a minimum clearance of 1.2 m [4 ft] should be provided from the traveled way to the barrier.

Although it is desirable that a shoulder be wide enough for a vehicle to be driven completely off the traveled way, narrower shoulders are better than none at all. For example, when a vehicle making an emergency stop can pull over onto a narrow shoulder such that it occupies only 0.3 to 1.2 m [1 to 4 ft] of the traveled way, the remaining traveled way width can be used by passing vehicles. Partial shoulders are sometimes used where full shoulders are unduly costly, such as on long (over 60 m [200 ft]) bridges or in mountainous terrain.

Regardless of the width, a shoulder should be continuous. The full benefits of a shoulder may not be realized unless it provides a driver with refuge at any point along the traveled way. A continuous shoulder provides a sense of security such that almost all drivers making emergency stops will leave the traveled way. With intermittent sections of shoulder, however, some drivers will find it necessary to stop on the traveled way, creating an undesirable situation. A continuous paved shoulder also provides an area for bicyclists to operate without obstructing faster moving motor vehicle traffic. Although continuous shoulders are preferable, narrow shoulders and intermittent shoulders are superior to no shoulders.

Shoulders on structures should normally have the same width as usable shoulders on the approach roadways. Long, high-cost structures may need detailed studies to determine practical dimensions, and reduced shoulder widths may be considered.

Lanes and Shoulders Widths

- **Rural Local Roads Widths:** Table 2.5 provides the minimum width of the travelled way and shoulder for a rural local road.
- **Urban Local Roads Widths:** Street lanes for moving traffic preferably should be 3.0 to 3.3 m [10 to 11 ft] wide, and in industrial areas they should be 3.6 m [12 ft] wide. Where the available or attainable width of right-of-way imposes severe limitations, 2.7-m [9-ft] lanes can be used in residential areas, and 3.3-m [11-ft] lanes can be used in industrial areas. Added turning lanes where used at intersections should be at least 2.7 m [9 ft] wide, and desirably 3.0 to 3.6 m [10 to 12 ft] wide, depending on the percentage of trucks. Where used in residential areas, a parallel parking lane at least 2.1 m [7 ft] wide should be provided on one or both sides of the street, as appropriate to the conditions of lot size and intensity of development. In commercial and industrial areas, parking lane widths should be at least 2.4 m [8 ft] and are usually provided on both sides of the street.
- **Rural Collector Roads Widths:** Table 2.6 provides the minimum width of the travelled way and shoulder for a rural collector road.

Table 2.5 Minimum Width of Traveled Way and Shoulders for Rural Local Roads

| Metric | | | | | U.S. Customary | | | | |
|---------------------|---|---------------------|------------------|------------------|--------------------|--|------------------|-----------------|-----------------|
| Design Speed (km/h) | Minimum Width of Traveled Way (m) for Specified Design Volume (veh/day) | | | | Design Speed (mph) | Minimum Width of Traveled Way (ft) for Specified Design Volume (veh/day) | | | |
| | under 400 | 400 to 1500 | 1500 to 2000 | over 2000 | | under 400 | 400 to 1500 | 1500 to 2000 | over 2000 |
| 20 | 5.4 | 6.0 ^a | 6.0 | 6.6 | 15 | 18 | 20 ^a | 20 | 22 |
| 30 | 5.4 | 6.0 ^a | 6.6 | 7.2 ^b | 20 | 18 | 20 ^a | 22 | 24 ^b |
| 40 | 5.4 | 6.0 ^a | 6.6 | 7.2 ^b | 25 | 18 | 20 ^a | 22 | 24 ^b |
| 50 | 5.4 | 6.0 ^a | 6.6 | 7.2 ^b | 30 | 18 | 20 ^a | 22 | 24 ^b |
| 60 | 5.4 | 6.0 ^a | 6.6 | 7.2 ^b | 40 | 18 | 20 ^a | 22 | 24 ^b |
| 70 | 6.0 | 6.6 | 6.6 | 7.2 ^b | 45 | 20 | 22 | 22 | 24 ^b |
| 80 | 6.0 | 6.6 | 6.6 | 7.2 ^b | 50 | 20 | 22 | 22 | 24 ^b |
| 90 | 6.6 | 6.6 | 7.2 ^b | 7.2 ^b | 55 | 22 | 22 | 24 ^b | 24 ^b |
| 100 | 6.6 | 6.6 | 7.2 ^b | 7.2 ^b | 60 | 22 | 22 | 24 ^b | 24 ^b |
| | | | | | 65 | 22 | 22 | 24 ^b | 24 ^b |
| All speeds | Width of graded shoulder on each side of the road (m) | | | | All speeds | Width of graded shoulder on each side of the road (ft) | | | |
| | 0.6 | 1.5, ^{a,c} | 1.8 | 2.4 | | 2 | 5 ^{a,c} | 6 | 8 |

- ^a For roads in mountainous terrain with design volume of 400 to 600 veh/day, use 5.4-m [18-ft] traveled way width and 0.6-m [2-ft] shoulder width.
- ^b Where the width of the traveled way is shown as 7.2 m [24 ft], the width may remain at 6.6 m [22 ft] on reconstructed highways where there is no crash pattern suggesting the need for widening.
- ^c May be adjusted to achieve a minimum roadway width of 9 m [30 ft] for design speeds greater than 60 km/h [40 mph].

- **Urban Collector Roads Widths:** The width of an urban collector street should be planned as the sum of the widths of the ultimate number of lanes for moving traffic, parking, and bicycles, including median width where appropriate. Lanes within the traveled way should range in width from 3.0 to 3.6 m [10 to 12 ft]. In industrial areas, lanes should be 3.6 m [12 ft] wide except where lack of space for right-of-way imposes severe limitations; in such cases, lane widths of 3.3 m [11 ft] may be used. Added turning lanes at intersections, where used, should range in width from 3.0 to 3.6 m [10 to 12 ft], depending on the volume of trucks.

Where shoulders are provided, roadway widths in accordance with Table 2.6 should be considered. Although on-street parking may impede traffic flow and parked vehicles may at times be involved in crashes, provision of parking lanes parallel to the curb is needed to accommodate adjacent development on many collector streets. Parallel parking is normally acceptable on urban collectors where sufficient street width is available to provide a parking lane. In residential areas, a parallel parking lane from 2.1 to 2.4 m [7 to 8 ft] in width should be provided on one or both sides of

the street, as appropriate for the lot size and density of development. In commercial and industrial areas, parking lane widths should range from 2.4 to 3.3 m [8 to 11 ft] and are usually provided on both sides of the street.

Table 2.6 Minimum Width of Traveled Way and Shoulders for Rural Collector Roads

| Metric | | | | | U.S. Customary | | | | |
|---------------------|---|------------------|--------------|-----------|--------------------|--|------------------|--------------|-----------|
| Design Speed (km/h) | Minimum Width of Traveled Way (m) for Specified Design Volume (veh/day ^a) | | | | Design Speed (mph) | Minimum Width of Traveled Way (ft) for Specified Design Volume (veh/day ^a) | | | |
| | under 400 | 400 to 1500 | 1500 to 2000 | over 2000 | | under 400 | 400 to 1500 | 1500 to 2000 | over 2000 |
| 30 | 6.0 ^b | 6.0 | 6.6 | 7.2 | 20 | 20 ^b | 20 | 22 | 24 |
| 40 | 6.0 ^b | 6.0 | 6.6 | 7.2 | 25 | 20 ^b | 20 | 22 | 24 |
| 50 | 6.0 ^b | 6.0 | 6.6 | 7.2 | 30 | 20 ^b | 20 | 22 | 24 |
| 60 | 6.0 ^b | 6.6 | 6.6 | 7.2 | 35 | 20 ^b | 22 | 22 | 24 |
| 70 | 6.0 | 6.6 | 6.6 | 7.2 | 40 | 20 ^b | 22 | 22 | 24 |
| 80 | 6.0 | 6.6 | 6.6 | 7.2 | 45 | 20 | 22 | 22 | 24 |
| 90 | 6.6 | 6.6 | 7.2 | 7.2 | 50 | 20 | 22 | 22 | 24 |
| 100 | 6.6 | 6.6 | 7.2 | 7.2 | 55 | 22 | 22 | 24 | 24 |
| | | | | | 60 | 22 | 22 | 24 | 24 |
| | | | | | 65 | 22 | 22 | 24 | 24 |
| | Width of Shoulder on Each Side of Road (m) | | | | | Width of Shoulder on Each Side of Road (ft) | | | |
| All Speeds | 0.6 | 1.5 ^c | 1.8 | 2.4 | All Speeds | 2.0 | 5.0 ^c | 6.0 | 8.0 |

^a On roadways to be reconstructed, a 6.6-m [22-ft] traveled way may be retained where the alignment is satisfactory and there is no crash pattern suggesting the need for widening.

^b A 5.4-m [18-ft] minimum width may be used for roadways with design volumes under 250 veh/day.

^c Shoulder width may be reduced for design speeds greater than 50 km/h [30 mph] provided that a minimum roadway width of 9 m [30 ft] is maintained.

Note: See text for roadside barrier and off-tracking considerations.

- **Rural Arterial Roads Widths:** Table 2.7 provides the minimum width of the travelled way and shoulder for a rural arterial road.

Due to the high speeds and large volumes typically associated with divided arterials, they should be designed with lanes 3.6 m [12 ft] wide. On reconstructed arterials, it may be acceptable to retain 3.3 m [11-ft] lanes if the alignment is satisfactory and there is no crash pattern suggesting the need for widening.

Table 2.7 Minimum Width of Traveled Way and Shoulders for Rural Arterial Roads

| Metric | | | | | U.S. Customary | | | | |
|---------------------|--|-------------|--------------|-----------|--------------------|---|-------------|--------------|-----------|
| Design Speed (km/h) | Minimum Width of Traveled Way (m) ^a for Specified Design Volume (veh/day) | | | | Design Speed (mph) | Minimum Width of Traveled Way (ft) ^a for Specified Design Volume (veh/day) | | | |
| | under 400 | 400 to 1500 | 1500 to 2000 | over 2000 | | under 400 | 400 to 1500 | 1500 to 2000 | over 2000 |
| 60 | 6.6 | 6.6 | 6.6 | 7.2 | 40 | 22 | 22 | 22 | 24 |
| 70 | 6.6 | 6.6 | 6.6 | 7.2 | 45 | 22 | 22 | 22 | 24 |
| 80 | 6.6 | 6.6 | 7.2 | 7.2 | 50 | 22 | 22 | 24 | 24 |
| 90 | 6.6 | 6.6 | 7.2 | 7.2 | 55 | 22 | 22 | 24 | 24 |
| 100 | 7.2 | 7.2 | 7.2 | 7.2 | 60 | 24 | 24 | 24 | 24 |
| 110 | 7.2 | 7.2 | 7.2 | 7.2 | 65 | 24 | 24 | 24 | 24 |
| 120 | 7.2 | 7.2 | 7.2 | 7.2 | 70 | 24 | 24 | 24 | 24 |
| 130 | 7.2 | 7.2 | 7.2 | 7.2 | 75 | 24 | 24 | 24 | 24 |
| All Speeds | Width of Usable Shoulder (m) ^b | | | | All Speeds | Width of Usable Shoulder (ft) ^b | | | |
| | 1.2 | 1.8 | 1.8 | 2.4 | | 4 | 6 | 6 | 8 |

^a On roadways to be reconstructed, an existing 6.6-m [22-ft] traveled way may be retained where the alignment is satisfactory and there is no crash pattern suggesting the need for widening.

^b Preferably, usable shoulders on arterials should be paved; however, where volumes are low or a narrow section is needed to reduce construction impacts, the paved shoulder width may be a minimum of 0.6 m [2 ft] provided that bicycle use is not intended to be accommodated on the shoulder.

- Urban Arterial Roads Widths:** Lane widths may vary from 3.0 to 3.6 m [10 to 12 ft]. Lane widths of 3.0 m [10 ft] may be used in more constrained areas where truck and bus volumes are relatively low and speeds are less than 60 km/h [35 mph]. Lane widths of 3.3 m [11 ft] are used quite extensively for urban arterial street designs. The 3.6-m [12-ft] lane widths are desirable, where practical, on high-speed, free-flowing, principal arterials.

Under interrupted-flow operating conditions at low speeds (70 km/h [45 mph] or less), narrower lane widths are normally adequate and have some advantages. For example, reduced lane widths allow more lanes to be provided in areas with restrictive right-of-way and allow shorter pedestrian crossing times because of reduced crossing distances. Arterials with reduced lane widths are also more economical to construct. A 3.3-m [11-ft] lane width is adequate for through lanes, continuous two-way left-turn lanes, and lanes adjacent to a painted median. Left-turn and combination lanes used for parking during off-peak hours and for traffic during peak hours may be 3.0 m [10 ft] in width.

If substantial truck traffic is anticipated, additional lane width may be desirable. The widths needed for all lanes and intersection design controls should be evaluated collectively. For instance, a wider right-hand lane that provides for right turns without

encroachment on adjacent lanes may be attained by providing a narrower left-turn lane. Local practice and experience regarding lane widths should also be evaluated.

Shoulders are desirable on any highway, and urban arterials are no exception. They contribute to reducing crash frequencies by affording maneuver room and providing space for immobilized vehicles. They provide space for walking by occasional pedestrians in sparsely developed areas where sidewalks are not appropriate and can provide space for bicyclists. They also serve as speed-change lanes for vehicles turning into driveways and intersections and provide storage space for plowed snow. Despite the many advantages of shoulders on arterial streets, their use is generally limited by restricted right-of-way and the need to use the available right-of-way for traffic or parking lanes. Where the abutting property is used for commercial purposes or consists of high-density residential development, a shoulder, if provided, is subject to such heavy use in serving local traffic that the pavement strength of the shoulder should be about the same as that for the travel lanes.

- **Rural and Urban Freeway Roads Widths:** Freeways should have a minimum of two through-traffic lanes for each direction of travel. Through traffic lanes should be 3.6 m [12 ft] wide.

Paved shoulders should be continuous on both the right and left sides of all freeway facilities. On four-lane freeways, the median (or left) shoulder is normally 1.2 to 2.4 m [4 to 8 ft] wide, at least 1.2 m [4 ft] of which should be paved and the remainder stabilized. The paved width of the right shoulder should be at least 3.0 m [10 ft]; where the DDHV for truck traffic exceeds 250 veh/h, a paved right shoulder width of 3.6 m [12 ft] should be considered. On freeways with six or more lanes, the paved width of the right and left shoulder should be 3.0 m [10 ft]; where the DDHV for truck traffic exceeds 250 veh/h, a paved shoulder width of 3.6 m [12 ft] should be considered.

Cross Slopes

- **Rural Local Roads:** Traveled-way cross slope should be adequate to provide proper drainage. Normally, cross slopes range from 1.5 to 2 percent for paved surfaces and 2 to 6 percent for unpaved surfaces. For unpaved surfaces, such as stabilized or loose gravel, and for stabilized earth surfaces, a 3 percent cross slope is desirable.
- **Urban Local Roads:** Pavement cross slope should be adequate to provide proper drainage. Normally cross slopes range from 1.5 to 2 percent for paved surfaces and 2 to 6 percent for unpaved surfaces where there are flush shoulders. Where there are outer curbs, cross slopes steeper than the guidelines given above by about 0.5 to 1 percent are desirable for the lane adjacent to the curb. For unpaved surfaces, such as

stabilized or loose gravel or stabilized earth surfaces, a 3 percent cross slope is desirable.

- **Rural Collector Roads:** Traveled way cross slopes provide proper drainage. Normally, cross slopes range from 1.5 to 2 percent for paved roadways. Paved roadways are those that retain smooth riding qualities and good non-skid properties in all weather conditions under heavy traffic volumes and loadings with little required maintenance. Unpaved roadways are those with treated earth surfaces and those with loose aggregate surfaces. A cross slope of 3 to 6 percent is desirable for unpaved roadways.
- **Urban Collector Roads:** Traveled-way cross slope should be adequate to provide proper drainage. Cross slope should normally be from 1.5 to 3 percent where there are flush shoulders adjacent to the traveled way or where there are outer curbs.
- **Rural Arterial Roads:** Cross slope is provided to enhance roadway drainage. Two-lane rural roadways are normally designed with a centerline crown and traveled-way cross slopes ranging from 1.5 to 2 percent with the higher values being most prevalent.

When three or more lanes are inclined in the same direction on multilane divided arterials, each successive pair of lanes outward from the first two lanes adjacent to the crown line may have an increased slope. A cross slope should not normally exceed 3 percent on tangent alignment, however. In no case should the cross slope of an outer or auxiliary lane, or both, be less than that of the adjacent lane.

- **Urban Arterial Roads:** Sufficient cross slope for adequate pavement drainage is important on urban arterials. The typical problems related to splashing and hydroplaning are compounded by heavy traffic volumes and curbed sections, especially for higher speeds. Cross slopes should range from 1.5 to 3 percent; the lower portion of this range is appropriate where drainage flow is across a single lane and higher values are appropriate where flow is across several lanes. Even higher cross-slope rates may be used for parking lanes. The overall cross section should provide a smooth appearance without sharp breaks, especially within pedestrian access routes where specific accessibility guidelines apply. Because urban arterials are often curbed, it is necessary to provide for longitudinal as well as cross-slope drainage. The use of higher cross-slope rates also reduces flow on the roadway and ponding of water due to pavement irregularities and rutting.

- **Rural and Urban Freeways:** Pavement cross slopes should range between 1.5 and 2 percent on tangent sections, with the higher value recommended for areas with moderate rainfall. For areas of heavy rainfall, a pavement cross slope of 2.5 percent may be needed to provide adequate drainage.

Design of the Alignment

The alignment of a highway is composed of vertical and horizontal elements. The vertical alignment includes straight (tangent) highway grades and the parabolic curves that connect these grades. The horizontal alignment includes the straight (tangent) sections of the roadway and the circular curves that connect their change in direction.

The design of the alignment depends primarily on the design speed selected for the highway. The least costly alignment is one that takes the form of the natural topography. It is not always possible to select the lowest cost alternative because the designer must adhere to certain standards that may not exist on the natural topography. It is important that the alignment of a given section has consistent standards to avoid sudden changes in the vertical and horizontal layout of the highway. It is also important that both horizontal and vertical alignments be designed to complement each other, since this will result in a safer and more attractive highway. One factor that should be considered to achieve compatibility is the proper balancing of the grades of tangents with curvatures of horizontal curves and the location of horizontal and vertical curves with respect to each other. For example, a design that achieves horizontal curves with large radii at the expense of steep or long grades is a poor design. Similarly, if sharp horizontal curves are placed at or near the top of pronounced crest vertical curves at or near the bottom of a pronounced sag vertical curve, a hazardous condition will be created at these sections of the highway. Thus, it is important that coordination of the vertical and horizontal alignments be considered at the early stages of preliminary design.

Clear Zones

The term “clear zone” is used to designate the unobstructed, traversable area provided beyond the edge of the traveled way for the recovery of errant vehicles. The clear zone includes shoulders, bicycle lanes, and auxiliary lanes unless the auxiliary lane functions like a through lane. Table 2.8 provides the clear zone requirements for all types of roadways.

Table 2.8 Clear Zones

| Location | Functional Classification | Design Speed (mph) | Avg. Daily Traffic | Clear Zone Width (ft) ^{3,4,5} | |
|----------|---------------------------|--------------------|--------------------|--|-----------------|
| | | | | Minimum | Desirable |
| - | - | - | - | Minimum | Desirable |
| Rural | Freeways | All | All | 30 (16 for ramps) | |
| Rural | Arterial | All | 0 - 750 | 16 | 30 |
| | | | 750 - 1500 | 30 | -- |
| | | | >1500 | 30 | -- |
| Rural | Collector | ≥ 50 | All | Use above rural arterial criteria. | |
| Rural | Collector | ≤ 45 | All | 10 | -- |
| Rural | Local | All | All | 10 | -- |
| Suburban | All | All | <8,000 | 10 ⁶ | 10 ⁶ |
| Suburban | All | All | 8,000 - 12,000 | 10 ⁶ | 20 ⁶ |
| Suburban | All | All | 12,000 - 16,000 | 10 ⁶ | 25 ⁶ |
| Suburban | All | All | >16,000 | 20 ⁶ | 30 ⁶ |
| Urban | Freeways | All | All | 30 (16 for ramps) | |
| Urban | All (Curbed) | ≥ 50 | All | Use above suburban criteria insofar as available border width permits. | |
| Urban | All (Curbed) | ≤ 45 | All | 4 from curb face | 6 |
| Urban | All (Uncurbed) | ≥ 50 | All | Use above suburban criteria. | |
| Urban | All (Uncurbed) | ≤ 45 | All | 10 | -- |

¹ Because of the need for specific placement to assist traffic operations, devices such as traffic signal supports, railroad signal/warning device supports, and controller cabinets are excluded from clear zone requirements. However, these devices should be located as far from the travel lanes as practical. Other non-breakaway devices should be located outside the prescribed clear zone or these devices should be protected with barrier.

² Average ADT over project life, i.e., 0.5 (present ADT plus future ADT). Use total ADT on two-way roadways and directional ADT on one-way roadways.

³ Without barrier or other safety treatment of appurtenances.

⁴ Measured from edge of travel lane for all cut sections and for all fill sections where side slopes are 1V:4H or flatter. Where fill slopes are steeper than 1V:4H it is desirable to provide a 10 ft area free of obstacles beyond the toe of slope.

⁵ Desirable, rather than minimum, values should be used where feasible.

⁶ Purchase of 5 ft or less of additional right-of-way strictly for satisfying clear zone provisions is not required.

3) Section 3 — Horizontal Alignment

The horizontal alignment consists of straight sections of the road (known as tangents) connected by curves. The curves are usually segments of circles, which have radii that will provide for a smooth flow of traffic. The design of the horizontal alignment entails the determination of the minimum radius, determination of the length of the curve, and the computation of the horizontal offsets from the tangents to the curve to facilitate locating the curve in the field. In some cases, to avoid a sudden change from a tangent with infinite radius to a curve of finite radius, a curve with radii varying from infinite to the radius of the circular curve is placed between the circular curve and the tangent. Such a curve is known as a spiral or transition curve. There are four types of horizontal curves: simple, compound, reversed, and spiral. Computations required for each type are presented in the following sections.

Stationing

Since stationing is fundamental to highway plans, it is felt that a discussion of stationing should be offered before you get involved with the plans. A station is the Horizontal measurement along the Survey Center Line of a project. Distances are measured and points are identified on plans with reference to Station Numbers. One hundred feet make up One Highway Station. Highway stationing might be compared with a rope having knots at 100-foot intervals. The beginning of the rope would be station 0+00, the first knot at 100 feet would be Station number 1 and would be written as 1+00. The second station number would be 2 (which is 200 feet from the beginning) and would be written as 2+00 and so on.

Simple Curves

Figure 3.1 is a layout of a simple horizontal curve. The curve is a segment of a circle with radius R that is always greater or equal to R_{\min} for the case when the stopping sight distance is not obstructed.

The relationship between R_{\min} and e_{\max} is:

$$R_{\min} = u_0^2 / (e_{\max} + f_s)$$

where:

R_{\min} = minimum radius (ft)

u_0 = design speed (mi/h)

e_{\max} = maximum superelevation (ft/ft)

f_s = coefficient of side friction (Table 3.1)

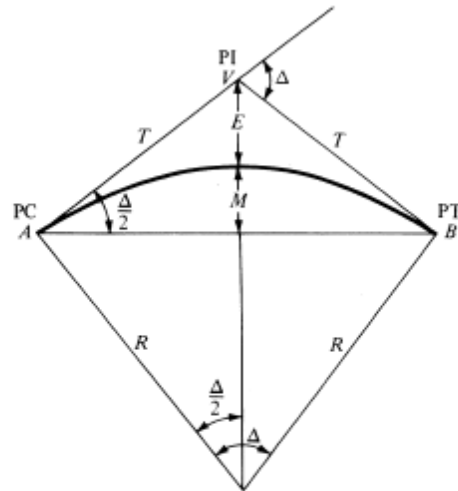

R = radius of circular curve *PC* = point of curve
T = tangent length *PT* = point of tangent
 Δ = intersection angle *PI* = point of intersection
M = middle ordinate *E* = external distance

Figure 3.1 Layout of a Simple Horizontal Curve

Table 3.1 Coefficient of Side Friction for Different Design Speeds

| Design Speed (mi/h) | Coefficients of Side Friction, f_s |
|---------------------|--------------------------------------|
| 30 | 0.20 |
| 40 | 0.16 |
| 50 | 0.14 |
| 60 | 0.12 |
| 70 | 0.10 |

Figure 3.2 is a layout of a simple horizontal curve for the case when the stopping sight distance is obstructed.

In this case:

$$m = R[1 - \cos(28.65 \cdot \text{SSD}/R)]$$

where:

m = the Horizontal Sightline Offset, HSO (ft)

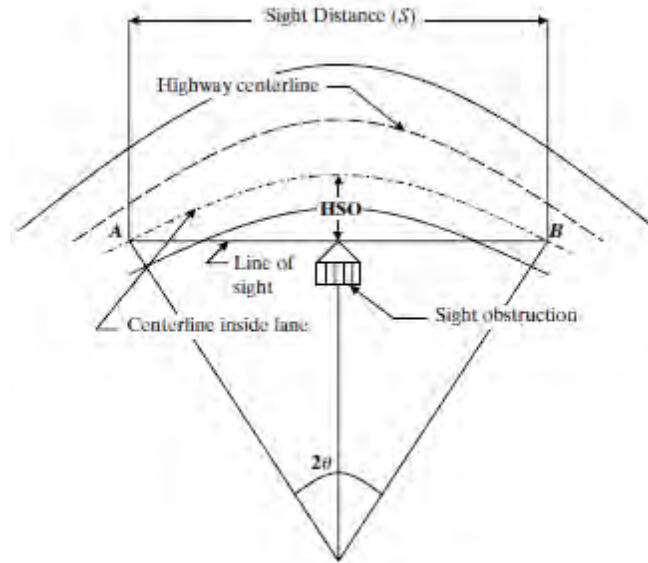

Figure 3.2 Horizontal Curves with Sight-Distance Restrictions

- Maximum Superelevation:** For local rural roads with paved surfaces, superelevation should be not more than 12 percent except where snow and ice conditions prevail, in which case the superelevation should be not more than 8 percent. For unpaved roads, the superelevation should be not more than 12 percent.

For local urban roads, street curves should be designed for a maximum superelevation rate of 4 percent. If the terrain dictates sharp curvature, a maximum superelevation rate of 6 percent may be justified if the curve is long enough to provide an adequate superelevation transition.

For rural collectors, superelevation should not exceed 12 percent. Where snow and ice conditions may be a factor, the superelevation rate should not exceed 8 percent.

For urban collectors, superelevation should be 6 percent or less.

For rural arterials, superelevation rates should not exceed 12 percent; however, where ice and snow conditions are a factor, the maximum superelevation rate should not exceed 8 percent.

For urban arterials, a rate of 4 or 6 percent is applicable for urban design in areas with few constraints, and superelevation may be omitted on low-speed urban streets where severe constraints are present

For freeways, maximum superelevation rates of 6 to 12 percent are applicable for freeways; however, where snow and ice conditions are a concern a

maximum rate of 6 to 8 percent should be considered. The maximum superelevation rates that are used on freeways that are either depressed, built at ground-level, or elevated on embankments are not generally applicable to elevated freeways on viaducts. Superelevation rates of 6 to 8 percent are generally the maximum that should be used on viaducts. The lower value may be used where freezing and thawing conditions are likely, because bridge decks generally freeze more rapidly than other roadway sections. Where freeways are intermittently elevated on viaducts, the lower superelevation rates should be used throughout for design consistency.

- **Control Parameters:** As Figure 3.1 illustrates, the point at which the curve begins (A) is known as the point of curve (PC), and the point at which it ends (B) is known as the point of tangent (PT). The point at which the two tangents intersect is known as the point of intersection (PI) or vertex (V). A simple circular curve is described either by its radius R, or by the degree of the curve D. There are two ways to define degree of the curve, which is based on 100 ft of arc length or on 100 ft of chord length. Highway practice (which is the focus of this section) uses arc definition whereas railroad practice uses chord definition.

The angle subtended at the center of a circular arc 100 ft in length as shown in Figure 3.3 is the degree of curve as used in highway work.

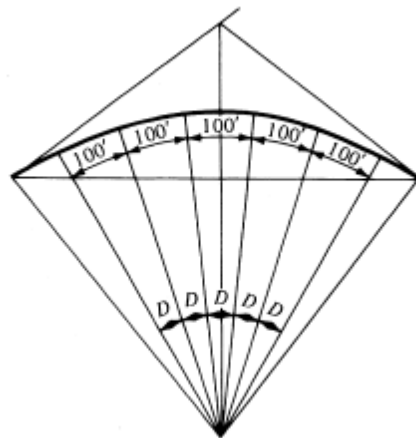

Figure 3.3 Arc Definition for a Circular Curve

The following equations apply for a simple curve:

$$R = 5729.6/D \text{ with } R_{\min} \leq R$$

$$L_{HC} = R\Delta\pi/180$$

$$T = R \tan(\Delta/2)$$

The length of the chord AB, which is known as the long chord $C = 2R \sin(\Delta/2)$

$$E = R[\sec(\Delta/2) - 1]$$

$$M = R[1 - \cos(\Delta/2)]$$

$$PT = PC + L_{HC}$$

$$PI = PC + T$$

Simple horizontal curves are usually located in the field by staking out points on the curve using angles measured from the tangent at the point of curve (PC) and the lengths of the chords joining consecutive whole stations. The angles are also called "deflection angles" because they are the angle that is "deflected" when the direction of the tangent changes direction to that of the chord. Figure 3.4 is a schematic of the procedure involved.

The first deflection angle VAp to the first whole station on the curve, which is usually less than a station away from the PC, is equal to $\delta_1/2$ based on the properties of a circle.

The next deflection angle VAq is $\delta_1/2 + D/2$; and the next deflection angle VAv is $\delta_1/2 + D/2 + D/2 = \delta_1/2 + D$; the next deflection angle VAs is $\delta_1/2 + 3D/2$; and the last deflection angle VAB is $\delta_1/2 + 3D/2 + \delta_2/2 = \Delta/2$.

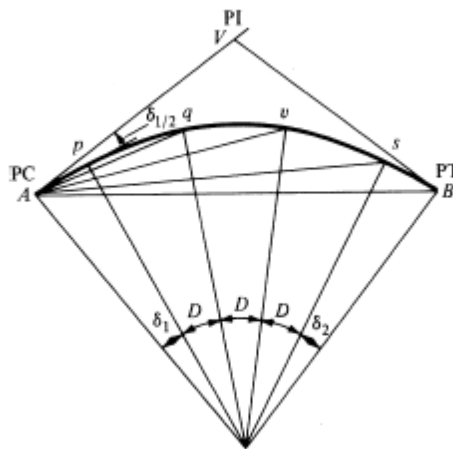

Figure 3.4 Deflection Angles on a Simple Circular Curve

If l_1 is the length of arc that encompasses δ_1 and l_2 is the length of arc that encompasses δ_2 , then the following equations apply:

$$\delta_1 = l_1 D / 100$$

$$\delta_2 = l_2D/100$$

$$\Delta = \delta_1 + \delta_2 + (\text{last whole station} - \text{first whole station})D$$

Once all the above-described parameters are computed, the actual superelevation shall be determined as per the following Figures 3.5, 3.6, 3.7, 3.8, 3.9, 3.10, 3.11, 3.12, 3.13, and 3.14 with e_{\max} varying from 4%, 6%, 8%, 10%, and 12%.

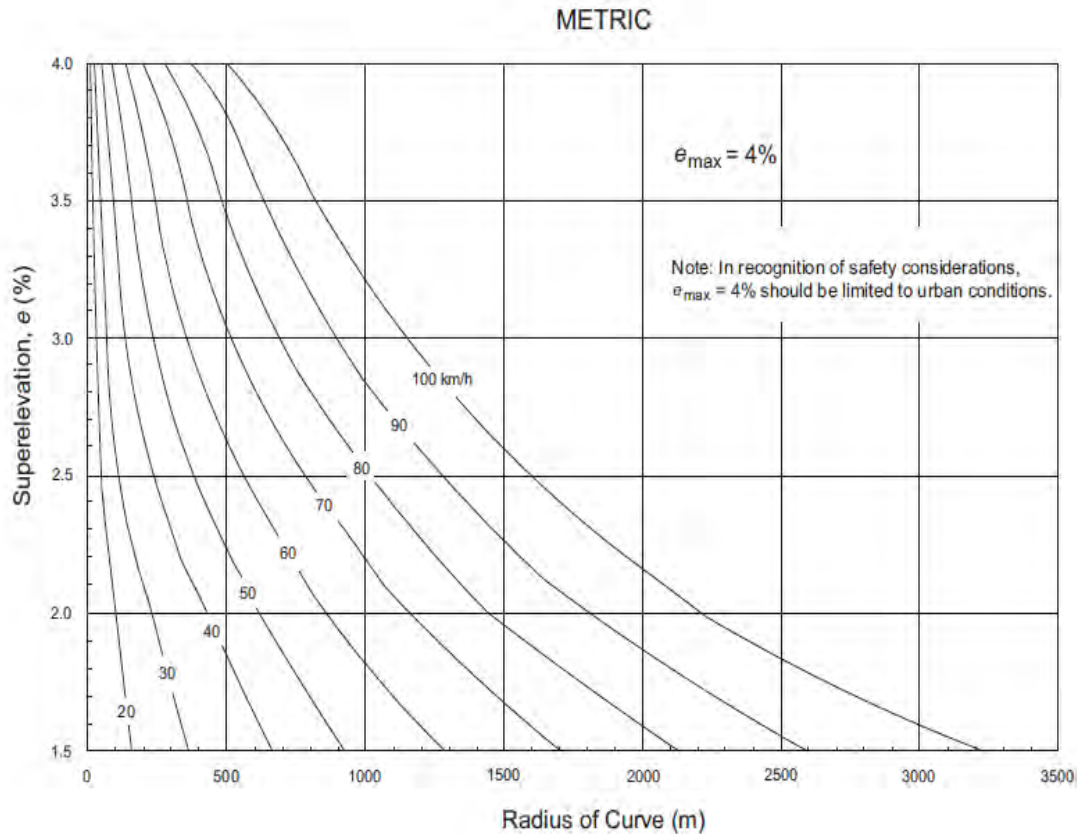

Figure 3.5 Design Superelevation Rates for e_{\max} of 4% (SI)

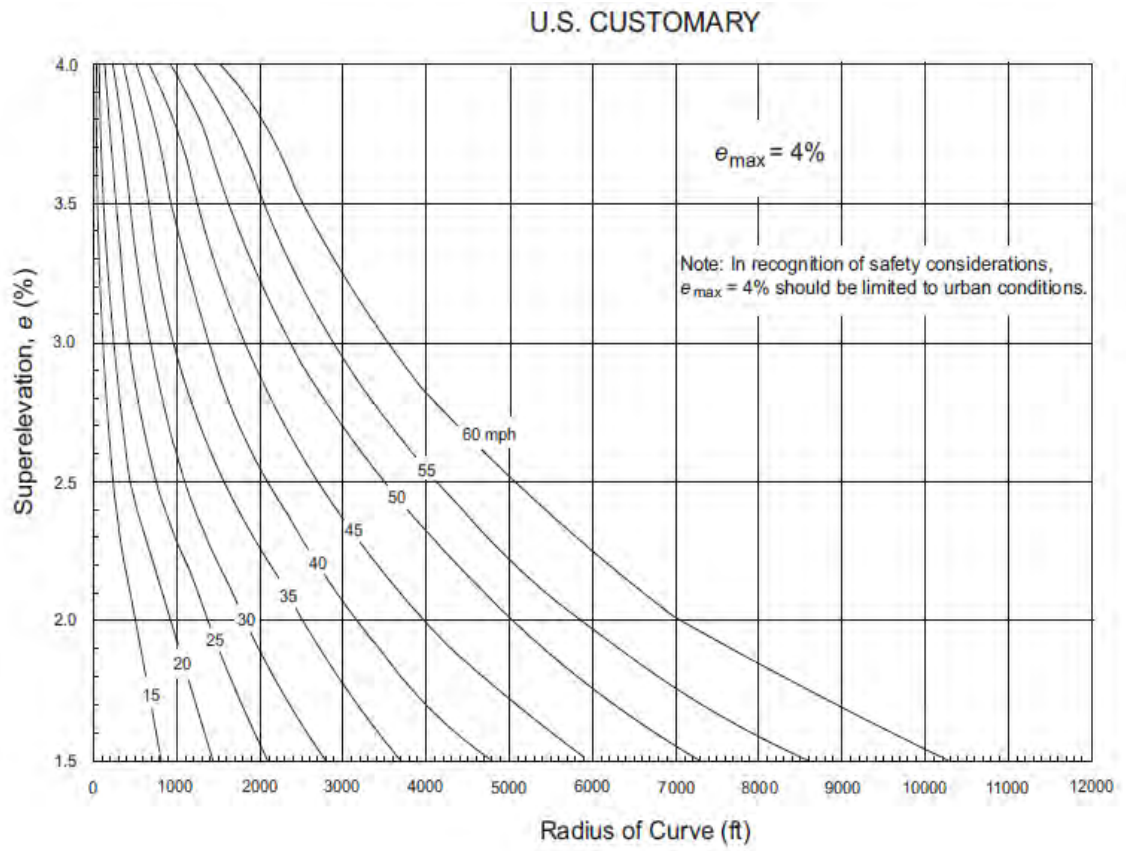

Figure 3.6 Design Superelevation Rates for e_{\max} of 4% (US)

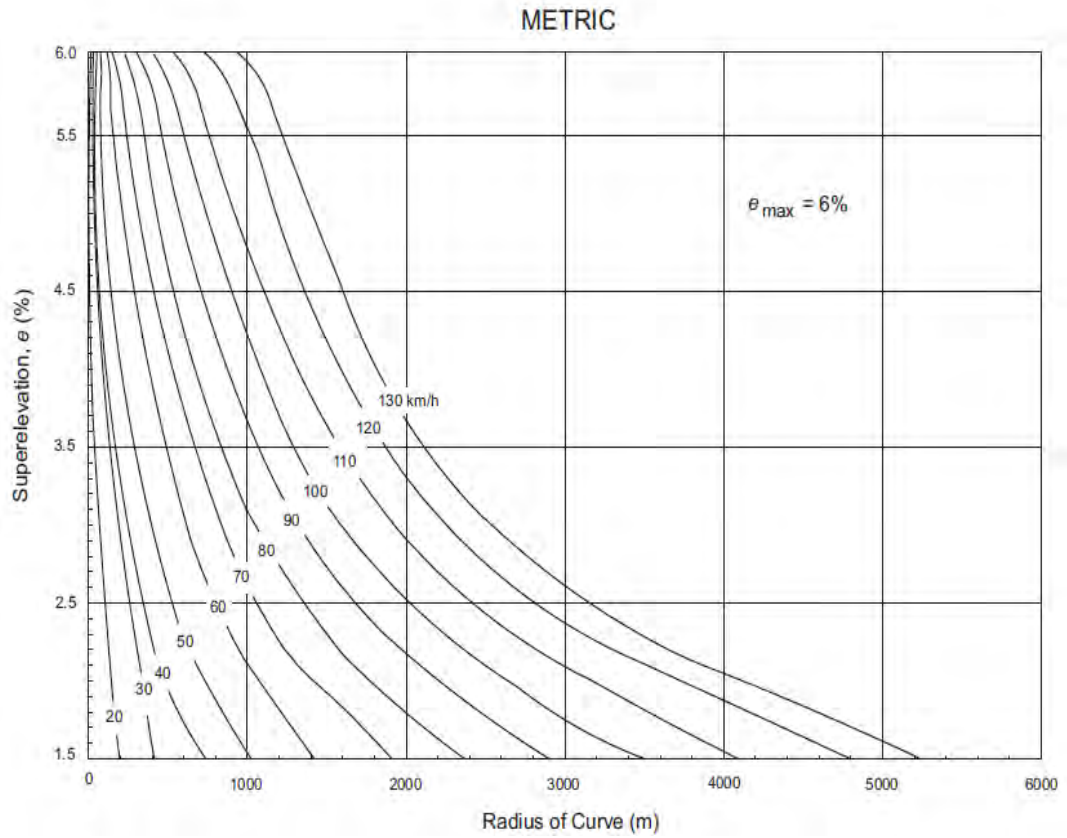

Figure 3.7 Design Superelevation Rates for e_{max} of 6% (SI)

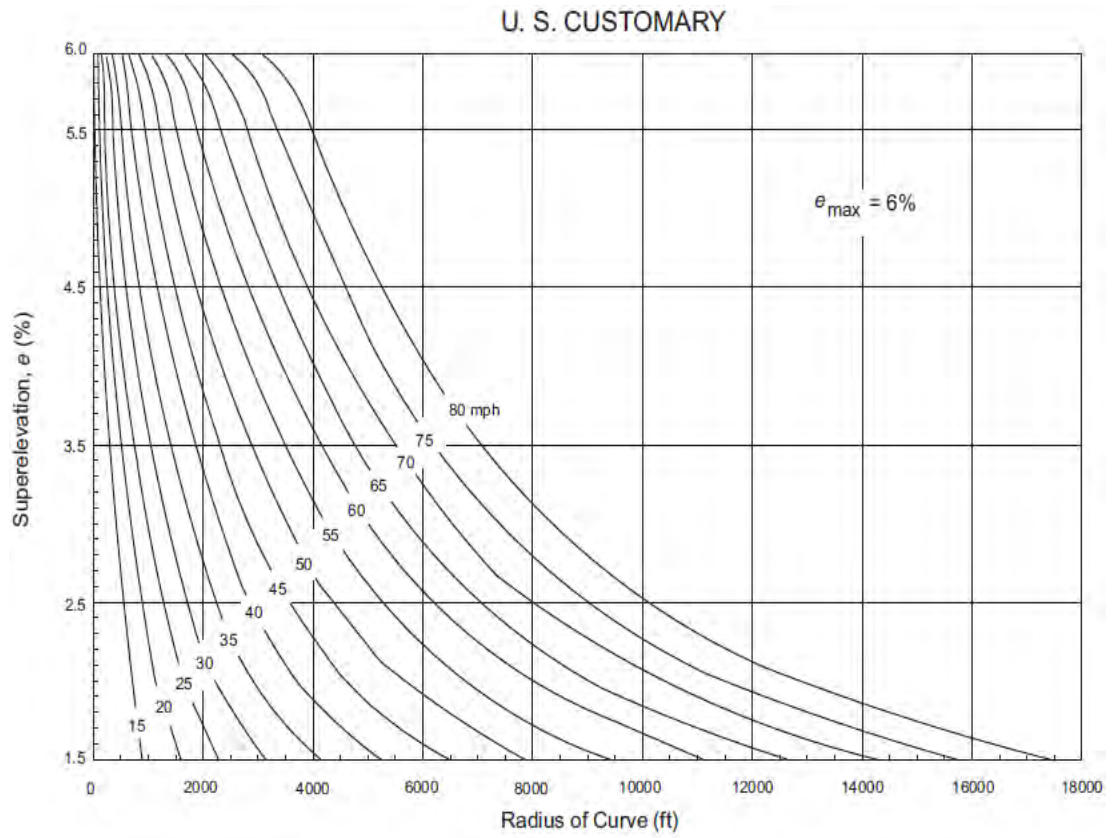

Figure 3.8 Design Superelevation Rates for e_{max} of 6% (US)

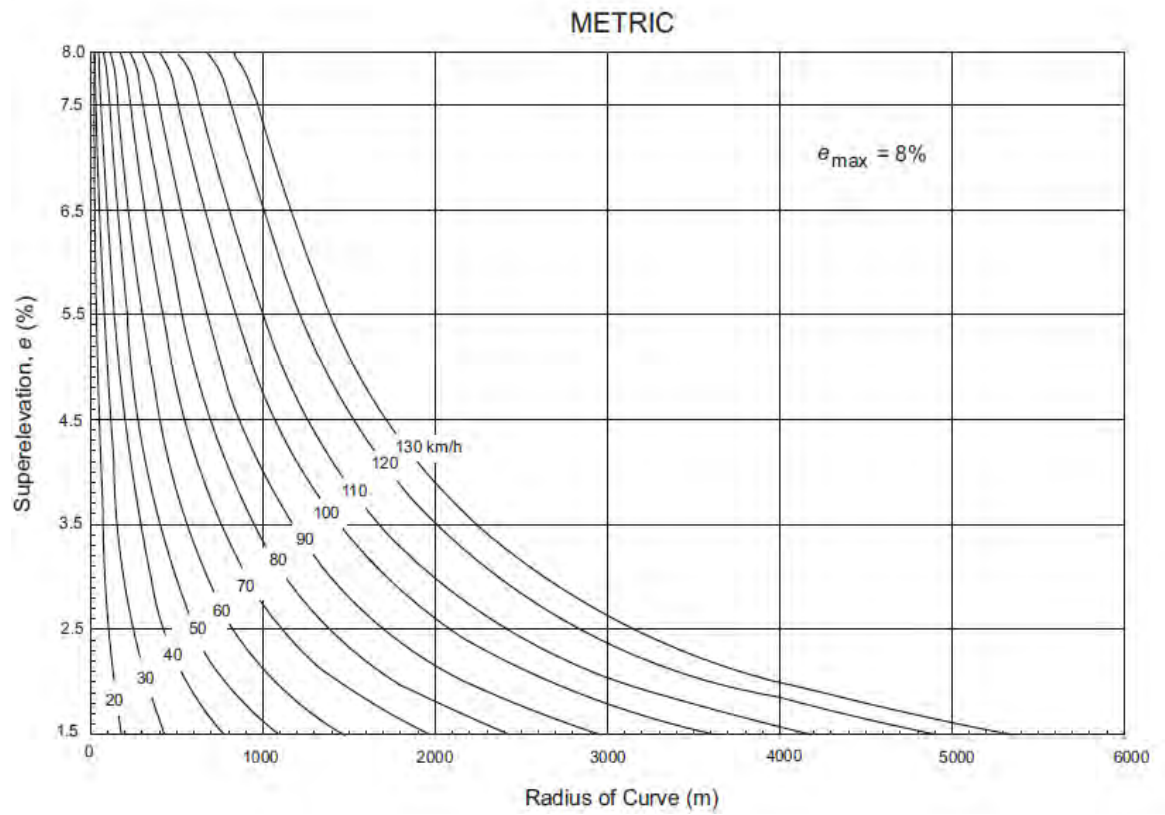

Figure 3.9 Design Superelevation Rates for e_{max} of 8% (SI)

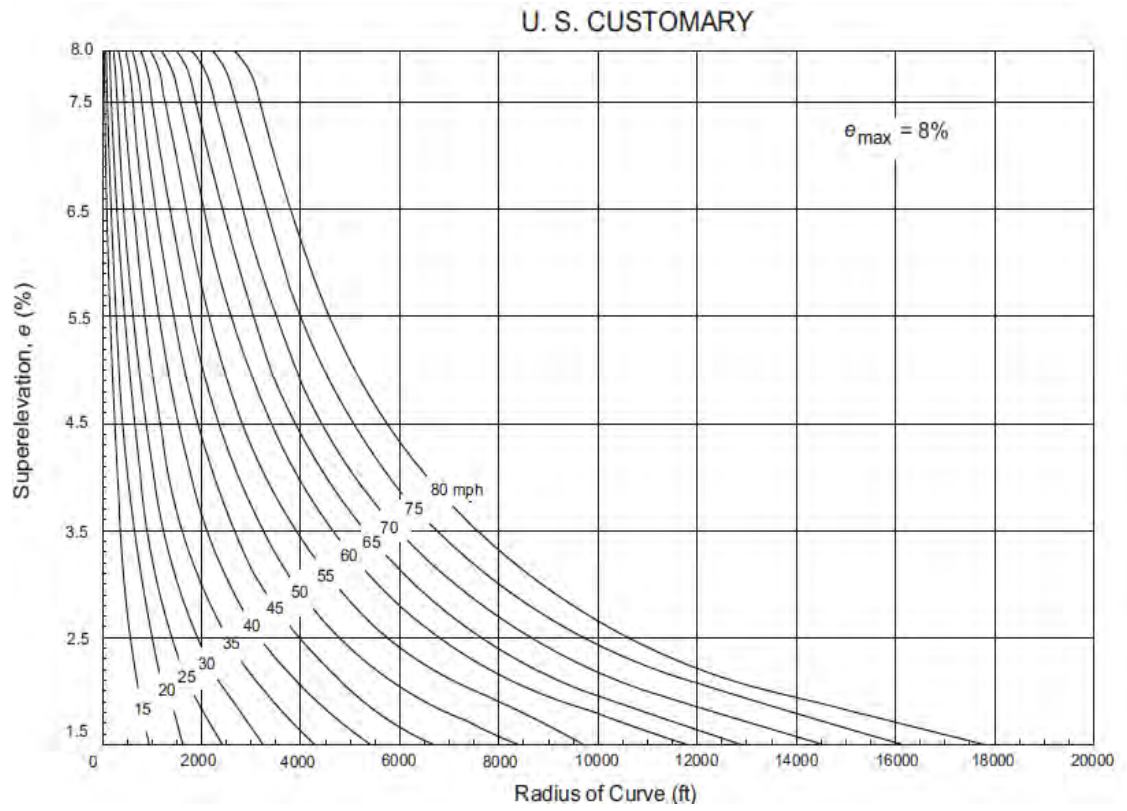

Figure 3.10 Design Superelevation Rates for e_{max} of 8% (US)

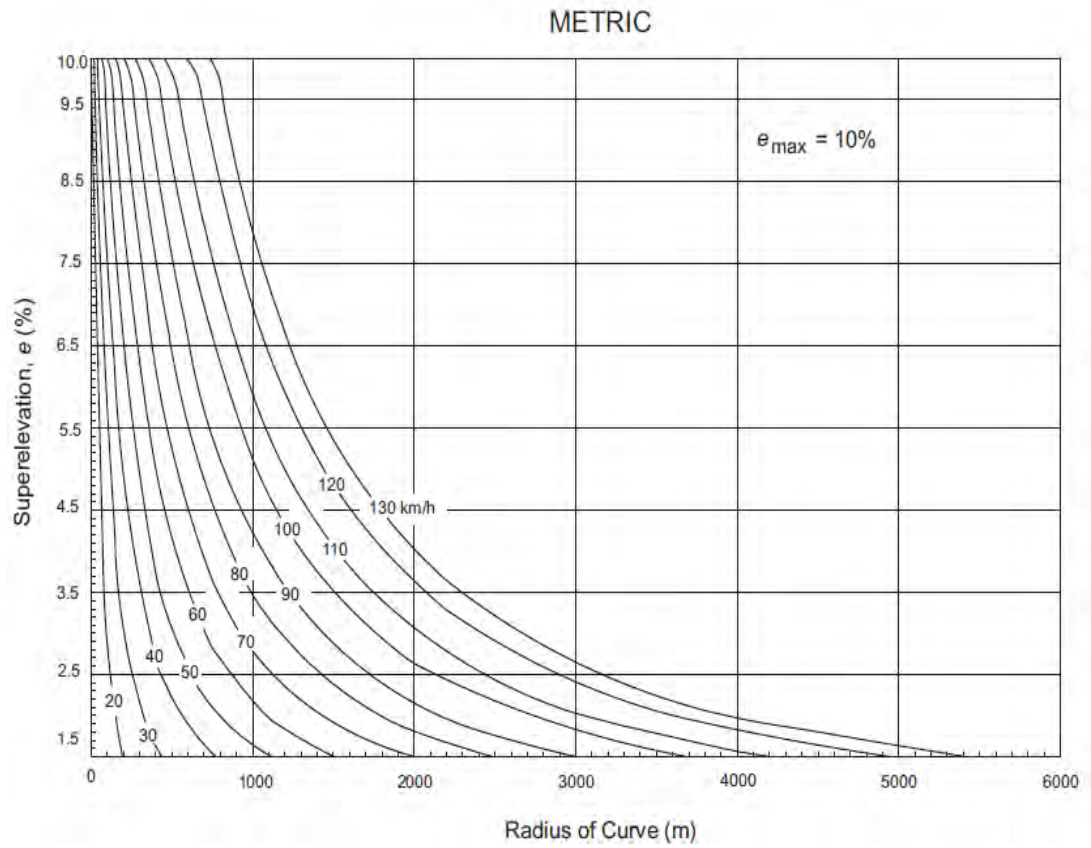

Figure 3.11 Design Superelevation Rates for e_{max} of 10% (SI)

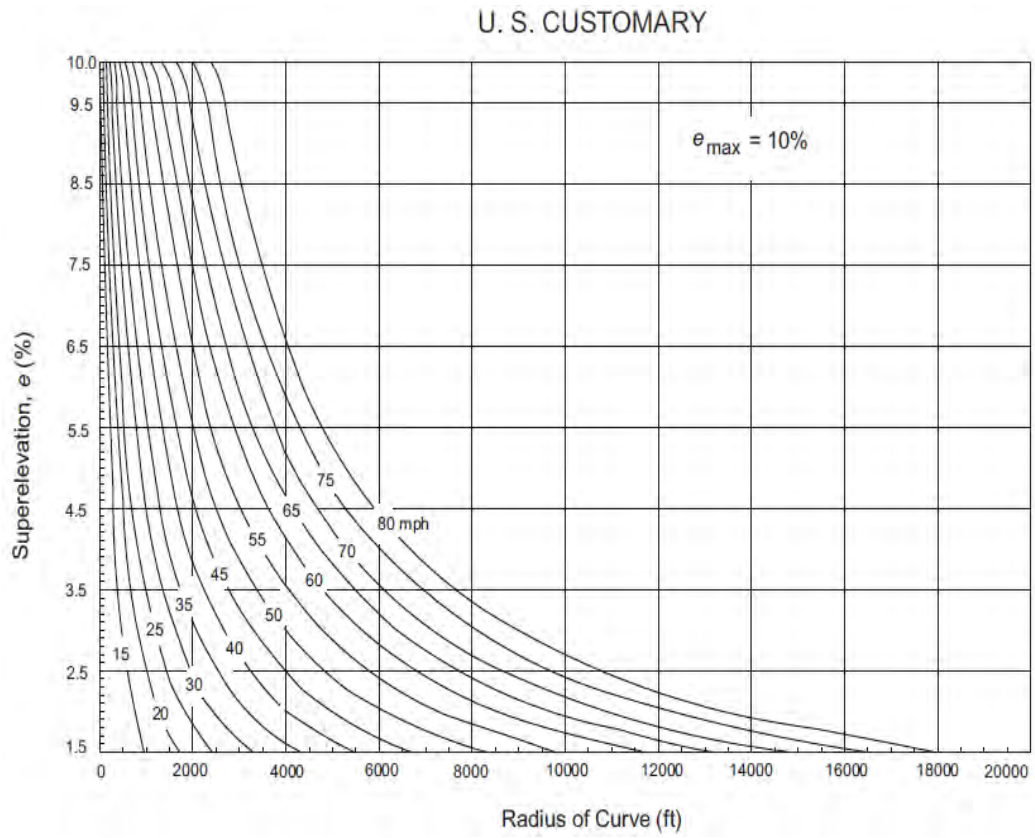

Figure 3.12 Design Superelevation Rates for e_{max} of 10% (US)

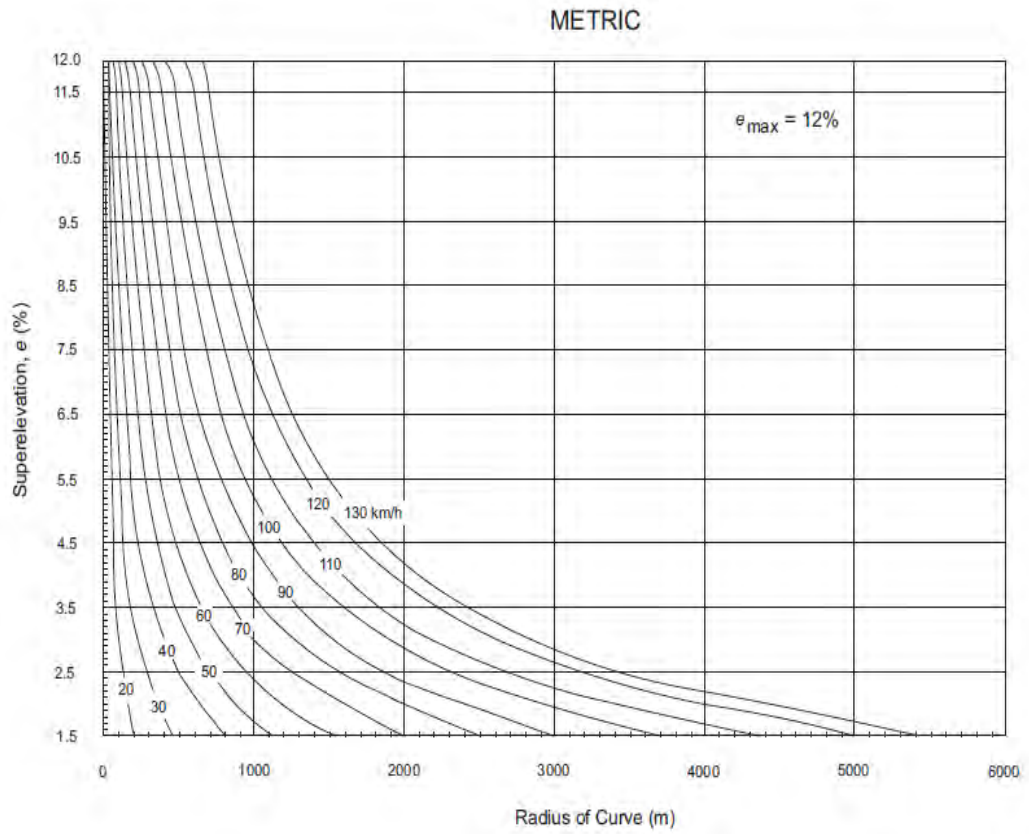

Figure 3.13 Design Superelevation Rates for e_{max} of 12% (SI)

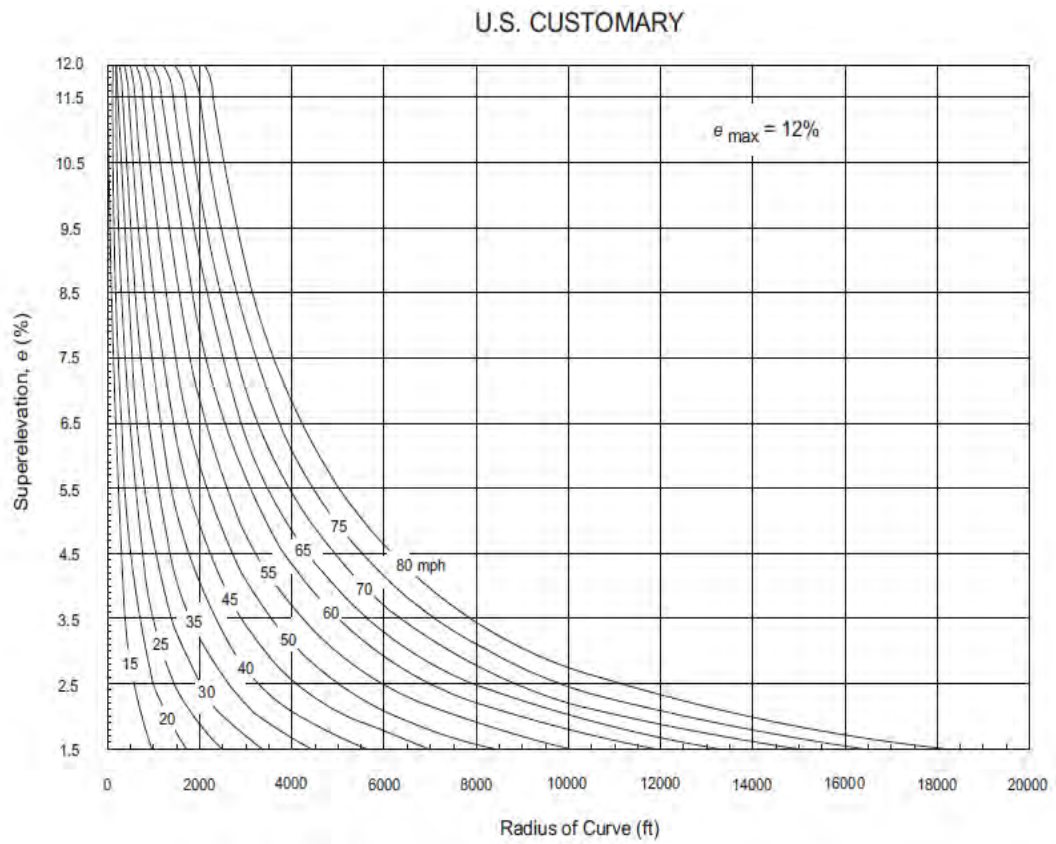

Figure 3.14 Design Superelevation Rates for e_{max} of 12% (US)

Table 3.2 shows minimum radius using limiting values of e and f_s .

Table 3.2 Minimum Radius Using Limiting Values of e and f

| Metric | | | | | | U.S. Customary | | | | | |
|--------------|-----------|-----------|-------------------|-----------------------|--------------------|----------------|-----------|-----------|-------------------|------------------------|---------------------|
| Design Speed | Maximum e | Maximum f | Total (e/100 + f) | Calculated Radius (m) | Rounded Radius (m) | Design Speed | Maximum e | Maximum f | Total (e/100 + f) | Calculated Radius (ft) | Rounded Radius (ft) |
| (km/h) | (%) | | | | | (mph) | (%) | | | | |
| 15 | 4.0 | 0.40 | 0.44 | 4.0 | 4 | 10 | 4.0 | 0.38 | 0.42 | 15.9 | 16 |
| 20 | 4.0 | 0.35 | 0.39 | 8.1 | 8 | 15 | 4.0 | 0.32 | 0.36 | 41.7 | 42 |
| 30 | 4.0 | 0.28 | 0.32 | 22.1 | 22 | 20 | 4.0 | 0.27 | 0.31 | 86.0 | 86 |
| 40 | 4.0 | 0.23 | 0.27 | 46.7 | 47 | 25 | 4.0 | 0.23 | 0.27 | 154.3 | 154 |
| 50 | 4.0 | 0.19 | 0.23 | 85.6 | 86 | 30 | 4.0 | 0.20 | 0.24 | 250.0 | 250 |
| 60 | 4.0 | 0.17 | 0.21 | 135.0 | 135 | 35 | 4.0 | 0.18 | 0.22 | 371.2 | 371 |
| 70 | 4.0 | 0.15 | 0.19 | 203.1 | 203 | 40 | 4.0 | 0.16 | 0.20 | 533.3 | 533 |
| 80 | 4.0 | 0.14 | 0.18 | 280.0 | 280 | 45 | 4.0 | 0.15 | 0.19 | 710.5 | 711 |
| 90 | 4.0 | 0.13 | 0.17 | 375.2 | 375 | 50 | 4.0 | 0.14 | 0.18 | 925.9 | 926 |
| 100 | 4.0 | 0.12 | 0.16 | 492.1 | 492 | 55 | 4.0 | 0.13 | 0.17 | 1186.3 | 1190 |
| | | | | | | 60 | 4.0 | 0.12 | 0.16 | 1500.0 | 1500 |
| 15 | 6.0 | 0.40 | 0.46 | 3.9 | 4 | 10 | 6.0 | 0.38 | 0.44 | 15.2 | 15 |
| 20 | 6.0 | 0.35 | 0.41 | 7.7 | 8 | 15 | 6.0 | 0.32 | 0.38 | 39.5 | 39 |
| 30 | 6.0 | 0.28 | 0.34 | 20.8 | 21 | 20 | 6.0 | 0.27 | 0.33 | 80.8 | 81 |
| 40 | 6.0 | 0.23 | 0.29 | 43.4 | 43 | 25 | 6.0 | 0.23 | 0.29 | 143.7 | 144 |
| 50 | 6.0 | 0.19 | 0.25 | 78.7 | 79 | 30 | 6.0 | 0.20 | 0.26 | 230.8 | 231 |
| 60 | 6.0 | 0.17 | 0.23 | 123.2 | 123 | 35 | 6.0 | 0.18 | 0.24 | 340.3 | 340 |
| 70 | 6.0 | 0.15 | 0.21 | 183.7 | 184 | 40 | 6.0 | 0.16 | 0.22 | 484.8 | 485 |
| 80 | 6.0 | 0.14 | 0.20 | 252.0 | 252 | 45 | 6.0 | 0.15 | 0.21 | 642.9 | 643 |
| 90 | 6.0 | 0.13 | 0.19 | 335.7 | 336 | 50 | 6.0 | 0.14 | 0.20 | 833.3 | 833 |
| 100 | 6.0 | 0.12 | 0.18 | 437.4 | 437 | 55 | 6.0 | 0.13 | 0.19 | 1061.4 | 1060 |
| 110 | 6.0 | 0.11 | 0.17 | 560.4 | 560 | 60 | 6.0 | 0.12 | 0.18 | 1333.3 | 1330 |
| 120 | 6.0 | 0.09 | 0.15 | 755.9 | 756 | 65 | 6.0 | 0.11 | 0.17 | 1656.9 | 1660 |
| 130 | 6.0 | 0.08 | 0.14 | 950.5 | 951 | 70 | 6.0 | 0.10 | 0.16 | 2041.7 | 2040 |
| | | | | | | 75 | 6.0 | 0.09 | 0.15 | 2500.0 | 2500 |
| | | | | | | 80 | 6.0 | 0.08 | 0.14 | 3047.6 | 3050 |
| 15 | 8.0 | 0.40 | 0.48 | 3.7 | 4 | 10 | 8.0 | 0.38 | 0.46 | 14.5 | 14 |
| 20 | 8.0 | 0.35 | 0.43 | 7.3 | 7 | 15 | 8.0 | 0.32 | 0.40 | 37.5 | 38 |
| 30 | 8.0 | 0.28 | 0.36 | 19.7 | 20 | 20 | 8.0 | 0.27 | 0.35 | 76.2 | 76 |
| 40 | 8.0 | 0.23 | 0.31 | 40.6 | 41 | 25 | 8.0 | 0.23 | 0.31 | 134.4 | 134 |
| 50 | 8.0 | 0.19 | 0.27 | 72.9 | 73 | 30 | 8.0 | 0.20 | 0.28 | 214.3 | 214 |
| 60 | 8.0 | 0.17 | 0.25 | 113.4 | 113 | 35 | 8.0 | 0.18 | 0.26 | 314.1 | 314 |
| 70 | 8.0 | 0.15 | 0.23 | 167.8 | 168 | 40 | 8.0 | 0.16 | 0.24 | 444.4 | 444 |
| 80 | 8.0 | 0.14 | 0.22 | 229.1 | 229 | 45 | 8.0 | 0.15 | 0.23 | 587.0 | 587 |
| 90 | 8.0 | 0.13 | 0.21 | 303.7 | 304 | 50 | 8.0 | 0.14 | 0.22 | 737.6 | 738 |
| 100 | 8.0 | 0.12 | 0.20 | 393.7 | 394 | 55 | 8.0 | 0.13 | 0.21 | 960.3 | 960 |
| 110 | 8.0 | 0.11 | 0.19 | 501.5 | 501 | 60 | 8.0 | 0.12 | 0.20 | 1200.0 | 1200 |
| 120 | 8.0 | 0.09 | 0.17 | 667.0 | 667 | 65 | 8.0 | 0.11 | 0.19 | 1482.5 | 1480 |
| 130 | 8.0 | 0.08 | 0.16 | 831.7 | 832 | 70 | 8.0 | 0.10 | 0.18 | 1814.8 | 1810 |
| | | | | | | 75 | 8.0 | 0.09 | 0.17 | 2203.9 | 2210 |
| | | | | | | 80 | 8.0 | 0.08 | 0.16 | 2666.7 | 2670 |
| 15 | 10.0 | 0.40 | 0.50 | 3.5 | 4 | 10 | 10.0 | 0.38 | 0.48 | 13.9 | 14 |
| 20 | 10.0 | 0.35 | 0.45 | 7.0 | 7 | 15 | 10.0 | 0.32 | 0.42 | 35.7 | 36 |
| 30 | 10.0 | 0.28 | 0.38 | 18.6 | 19 | 20 | 10.0 | 0.27 | 0.37 | 72.1 | 72 |
| 40 | 10.0 | 0.23 | 0.33 | 38.2 | 38 | 25 | 10.0 | 0.23 | 0.33 | 126.3 | 126 |
| 50 | 10.0 | 0.19 | 0.29 | 67.9 | 68 | 30 | 10.0 | 0.20 | 0.30 | 200.0 | 200 |
| 60 | 10.0 | 0.17 | 0.27 | 105.0 | 105 | 35 | 10.0 | 0.18 | 0.28 | 291.7 | 292 |
| 70 | 10.0 | 0.15 | 0.25 | 154.3 | 154 | 40 | 10.0 | 0.16 | 0.26 | 410.3 | 410 |
| 80 | 10.0 | 0.14 | 0.24 | 210.0 | 210 | 45 | 10.0 | 0.15 | 0.25 | 540.0 | 540 |
| 90 | 10.0 | 0.13 | 0.23 | 277.3 | 277 | 50 | 10.0 | 0.14 | 0.24 | 694.4 | 694 |
| 100 | 10.0 | 0.12 | 0.22 | 357.9 | 358 | 55 | 10.0 | 0.13 | 0.23 | 876.8 | 877 |
| 110 | 10.0 | 0.11 | 0.21 | 453.7 | 454 | 60 | 10.0 | 0.12 | 0.22 | 1090.9 | 1090 |
| 120 | 10.0 | 0.09 | 0.19 | 596.8 | 597 | 65 | 10.0 | 0.11 | 0.21 | 1341.3 | 1340 |
| 130 | 10.0 | 0.08 | 0.18 | 739.3 | 739 | 70 | 10.0 | 0.10 | 0.20 | 1633.3 | 1630 |
| | | | | | | 75 | 10.0 | 0.09 | 0.19 | 1873.7 | 1870 |
| | | | | | | 80 | 10.0 | 0.08 | 0.18 | 2370.4 | 2370 |
| 15 | 12.0 | 0.40 | 0.52 | 3.4 | 3 | 10 | 12.0 | 0.38 | 0.50 | 13.3 | 13 |
| 20 | 12.0 | 0.35 | 0.47 | 6.7 | 7 | 15 | 12.0 | 0.32 | 0.44 | 34.1 | 34 |
| 30 | 12.0 | 0.28 | 0.40 | 17.7 | 18 | 20 | 12.0 | 0.27 | 0.39 | 68.4 | 68 |
| 40 | 12.0 | 0.23 | 0.35 | 36.0 | 36 | 25 | 12.0 | 0.23 | 0.35 | 119.0 | 119 |
| 50 | 12.0 | 0.19 | 0.31 | 63.5 | 64 | 30 | 12.0 | 0.20 | 0.32 | 187.5 | 188 |
| 60 | 12.0 | 0.17 | 0.29 | 97.7 | 98 | 35 | 12.0 | 0.18 | 0.30 | 272.2 | 272 |
| 70 | 12.0 | 0.15 | 0.27 | 142.9 | 143 | 40 | 12.0 | 0.16 | 0.28 | 381.0 | 381 |
| 80 | 12.0 | 0.14 | 0.26 | 193.8 | 194 | 45 | 12.0 | 0.15 | 0.27 | 500.0 | 500 |
| 90 | 12.0 | 0.13 | 0.25 | 255.1 | 255 | 50 | 12.0 | 0.14 | 0.26 | 641.0 | 641 |
| 100 | 12.0 | 0.12 | 0.24 | 328.1 | 328 | 55 | 12.0 | 0.13 | 0.25 | 806.7 | 807 |
| 110 | 12.0 | 0.11 | 0.23 | 414.2 | 414 | 60 | 12.0 | 0.12 | 0.24 | 1000.0 | 1000 |
| 120 | 12.0 | 0.09 | 0.21 | 539.9 | 540 | 65 | 12.0 | 0.11 | 0.23 | 1224.6 | 1220 |
| 130 | 12.0 | 0.08 | 0.20 | 665.4 | 665 | 70 | 12.0 | 0.10 | 0.22 | 1484.8 | 1480 |
| | | | | | | 75 | 12.0 | 0.09 | 0.21 | 1783.7 | 1780 |
| | | | | | | 80 | 12.0 | 0.08 | 0.20 | 2133.3 | 2130 |

Note: In recognition of safety considerations, use of $e_{max} = 4.0\%$ should be limited to urban conditions.

Compound Curves

Compound curves consist of two or more simple curves in succession, turning in the same direction, with any two successive curves having a common tangent point. Figure 3.15 shows a typical layout of a compound curve, consisting of two simple curves. These curves are used mainly to obtain desirable shapes of the horizontal alignment, particularly for at-grade intersections, ramps of interchanges, and highway sections in difficult topographic areas. To avoid abrupt changes in the alignment, the radii of any two consecutive simple curves that form a compound curve should not be widely different. AASHTO recommends that the ratio of the flatter radius to the sharper radius at intersections should not be greater than 2:1 so drivers can adjust to sudden changes in curvature and speed. The maximum desirable ratio recommended for interchanges is 1.75:1, although 2:1 may be used.

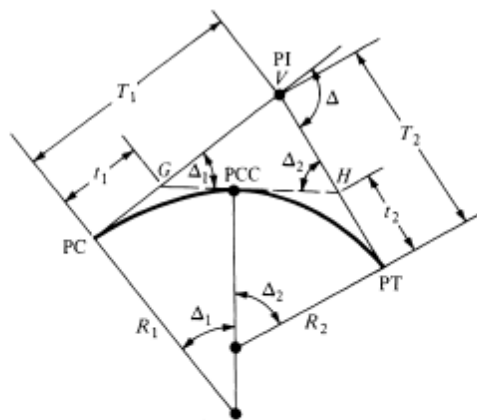

R_1, R_2 = radii of simple curves forming compound curve
 Δ_1, Δ_2 = intersection angles of simple curves
 Δ = intersection angle of compound curve
 t_1, t_2 = tangent lengths of simple curves
 T_1, T_2 = tangent lengths of compound curve
PCC = point of compound curve
PI = point of intersection
PC = point of curve
PT = point of tangent

Figure 3.15 Layout of a Compound Curve

To provide a smooth transition from a flat curve to a sharp curve, and to facilitate a reasonable deceleration rate on a series of curves of decreasing radii, the length of each curve should observe minimum length requirements, based on the radius of each curve as recommended by AASHTO and given in Table 3.3. Values in Table 3.3 are developed on the premise that travel is in the direction of the sharper curve. The 2:1 ratio of the flatter radius should preferably not be exceeded but is not critical for the acceleration condition.

Table 3.3 Lengths of Circular Arc for Compound Curves when Followed by a Curve of One-Half Radius or Preceded by a Curve of Double Radius

| Metric | | | U.S. Customary | | |
|-------------|----------------------------|-----------|----------------|-----------------------------|-----------|
| Radius (m) | Length of Circular Arc (m) | | Radius (ft) | Length of Circular arc (ft) | |
| | Minimum | Desirable | | Minimum | Desirable |
| 30 | 12 | 20 | 100 | 40 | 60 |
| 50 | 15 | 20 | 150 | 50 | 70 |
| 60 | 20 | 30 | 200 | 60 | 90 |
| 75 | 25 | 35 | 250 | 80 | 120 |
| 100 | 30 | 45 | 300 | 100 | 140 |
| 125 | 35 | 55 | 400 | 120 | 180 |
| 150 or more | 45 | 60 | 500 or more | 140 | 200 |

Figure 3.15 shows seven variables, R_1 , R_2 , Δ_1 , Δ_2 , Δ , T_1 , and T_2 , six of which are independent, since $\Delta = \Delta_1 + \Delta_2$. Several solutions can be developed for the compound curve. The vertex triangle method is presented since this method is frequently used in highway design. In Figure 3.15, R_1 and R_2 are usually known. Where the ratio is greater than 2:1, a suitable length of spiral or a circular arc of intermediate radius should be inserted between the two curves. The following equations can be used to determine the remaining variables:

$$\text{The intersection angle of the compound curve } \Delta = \Delta_1 + \Delta_2$$

$$\text{The tangent length of the first simple curve } t_1 = R_1 \tan(\Delta_1/2)$$

$$\text{The tangent length of the second simple curve } t_2 = R_2 \tan(\Delta_2/2)$$

$$\text{The tangent length of the compound curve } T_1 = VG + t_1$$

$$\text{The tangent length of the compound curve } T_2 = VH + t_2$$

$$VG/\sin(\Delta_2) = VH/\sin(\Delta_1) = (t_1 + t_2)/\sin(\Delta)$$

Reverse Curves

Reverse curves usually consist of two simple curves with equal radii turning in opposite directions with a common tangent. They are generally used to change the alignment of a highway. Figure 3.16 shows a reverse curve with parallel tangents.

The PC, PT, and the point of reverse curve (PRC) are located at points W, Y, and O, respectively.

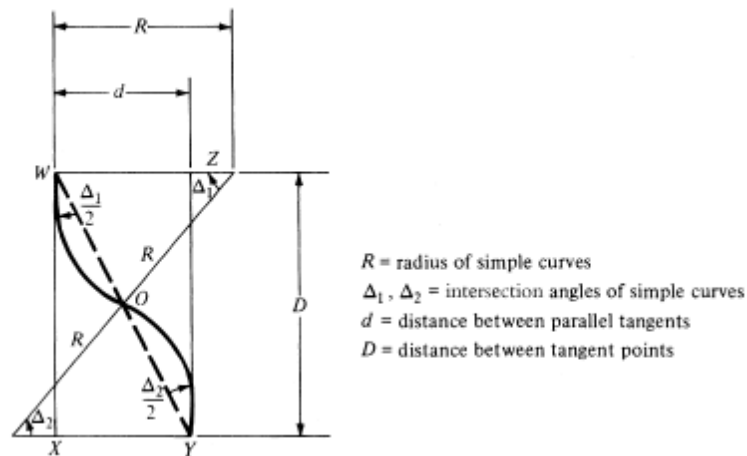

Figure 3.16 Layout of a Reverse Curve

The following equations can be used:

$$R = d/[1 - \cos(\Delta)]$$

$$D = d\cos(\Delta/2)$$

Reverse curves are seldom recommended because sudden changes to the alignment may result in drivers finding it difficult to keep in their lanes. When it is necessary to reverse the alignment, a preferable design consists of two simple horizontal curves, separated by a sufficient length of tangent between them, to achieve full superelevation. Alternatively, the simple curves may be separated by an equivalent length of spiral, which is described in the next section.

Transition Curves

Transition curves are placed between tangents and circular curves or between two adjacent circular curves having substantially different radii. The use of transition curves provides a vehicle path that gradually increases or decreases the radial force as the vehicle enters or leaves a circular curve.

- Length of Spiral Curves:** If the transition curve is a spiral, the degree of curve between the tangent and the circular curve varies from 0 at the tangent end to the degree of the circular curve D at the curve end. When the transition is placed between two circular curves, the degree of curve varies from that of the first circular curve to that of the second circular curve.

The expression given in the following equations is used by some highway agencies to

compute the minimum length of a spiral transition curve. The minimum length should be the larger of the values obtained from these equations:

$$L_{s,\min} = 3.15u^3/RC$$

$$L_{s,\min} = [24(\rho_{\min})R]^{1/2}$$

where:

L_s = minimum length of curve (ft)

u = speed (mi/h)

R = radius of curve (ft)

C = rate of increase of radial acceleration (ft /sec²/sec). Values range from 1 to 3.

ρ_{\min} = minimum lateral offset between the tangent and the circular curve (0.66 ft)

Table 3.4 shows the maximum radius for use of a spiral curve transition.

Table 3.4 Maximum Radius for Use of a Spiral Curve Transition

| Metric | | U.S. Customary | |
|---------------------|--------------------|--------------------|---------------------|
| Design speed (km/h) | Maximum radius (m) | Design speed (mph) | Maximum radius (ft) |
| 20 | 24 | 15 | 114 |
| 30 | 54 | 20 | 203 |
| 40 | 95 | 25 | 317 |
| 50 | 148 | 30 | 456 |
| 60 | 213 | 35 | 620 |
| 70 | 290 | 40 | 810 |
| 80 | 379 | 45 | 1025 |
| 90 | 480 | 50 | 1265 |
| 100 | 592 | 55 | 1531 |
| 110 | 716 | 60 | 1822 |
| 120 | 852 | 65 | 2138 |
| 130 | 1000 | 70 | 2479 |
| | | 75 | 2846 |
| | | 80 | 3238 |

Note: The effect of spiral curve transitions on lateral acceleration is likely to be negligible for larger radii.

- Length of Superelevation Runoff when Spiral Curves are not Used:** Many highway agencies do not use spiral transition curves since drivers will usually guide their vehicles into circular curves gradually. Under these conditions, the tangent is joined directly with the main circular curve (called “tangent-to-curve transition”); however, if the curve is superelevated at a rate of e ft /ft., an appropriate transition

length must be provided. This superelevation transition length is comprised of superelevation runoff and tangent runout. For highways where rotation is about any pavement reference line and the rotated width has a common superelevation, the following equation may be used to determine superelevation runoff:

$$L_r = (wn_1)(e_d)(b_w)/\Delta$$

where:

L_r = minimum length of superelevation runoff (ft)

Δ = maximum relative gradient (%) (0.78% @ 15 mph to 0.35% @ 80 mph)

n_1 = number of lanes rotated

b_w = adjustment factor for number of lanes rotated (1 = 1.00, 2 = 0.75, 3 = 0.67)

w = width of one traffic lane (ft) (typically 12 ft.)

e_d = design superelevation rate (%)

The AASHTO recommends minimum superelevation runoff lengths where either one or two lanes are rotated about the pavement edge as shown in Table 3.5. These values are based on concerns for appearance and comfort; thus a maximum acceptable difference between the longitudinal grades of the centerline (or axis of rotation) and the edge of the pavement. In this case, superelevation runoff is defined as the distance over which the pavement cross slope on the outside lane changes from zero (flat) to full superelevation of the curve (e).

Typically, the runoff length is divided between the tangent and the curved section and avoids placing the runoff either entirely on the tangent or the curve. Theoretically, superelevation runoff should be placed entirely on the tangent section thus providing full superelevation between the PC and PT. In practice, sharing the runoff between tangent and curve reduces peak lateral acceleration and its effect on side friction. Motorists tend to adjust their driving path by steering a “natural spiral” thus supporting the observation that some of the runoff length should be on the curve.

The length of the tangent runout consists of the length of roadway needed to accomplish a change on the outside-lane cross slope from normal (i.e., 2 percent) to zero, or vice versa. The sum of the superelevation runoff and tangent runout comprises the total distance over which transition from normal crown to full superelevation is achieved. The following equation can be used to determine the minimum runout length. The values obtained by substituting appropriate values into the equation are similar to those shown in Table 3.6 for a cross-slope of 2 percent.

$$L_t = (eNC)(L_r)/e_d$$

where:

L_t = minimum length of tangent runout (ft)

e_{NC} = normal cross slope rate (%)

e_d = design superelevation rate (%)

L_r = minimum length of superelevation runoff (ft)

Table 3.5 Superelevation Runoff L_r (ft) for Horizontal Curves

| e (%) | Design Speed (mph) | | | | | | | | | | | | | |
|---------|--------------------|-----|-----|-----|-----|-----|-----|-----|-----|-----|-----|-----|-----|-----|
| | 20 | | 30 | | 40 | | 50 | | 60 | | 70 | | 80 | |
| | 1 | 2 | 1 | 2 | 1 | 2 | 1 | 2 | 1 | 2 | 1 | 2 | 1 | 2 |
| 1.5 | 0 | 0 | 0 | 0 | 0 | 0 | 0 | 0 | 0 | 0 | 0 | 0 | 0 | 0 |
| 2.0 | 32 | 49 | 36 | 55 | 41 | 62 | 48 | 72 | 53 | 80 | 60 | 90 | 69 | 103 |
| 3.0 | 49 | 73 | 55 | 82 | 62 | 93 | 72 | 108 | 80 | 120 | 90 | 135 | 103 | 154 |
| 4.0 | 65 | 97 | 73 | 109 | 83 | 124 | 96 | 144 | 107 | 160 | 120 | 180 | 137 | 206 |
| 5.0 | 81 | 122 | 91 | 136 | 103 | 155 | 120 | 180 | 133 | 200 | 150 | 225 | 171 | 257 |
| 6.0 | 97 | 146 | 109 | 164 | 124 | 186 | 144 | 216 | 160 | 240 | 180 | 270 | 207 | 309 |
| 7.0 | 114 | 170 | 127 | 191 | 145 | 217 | 168 | 252 | 187 | 280 | 210 | 315 | 240 | 360 |
| 8.0 | 130 | 195 | 145 | 218 | 166 | 248 | 192 | 288 | 213 | 320 | 240 | 360 | 274 | 411 |
| 9.0 | 146 | 219 | 164 | 245 | 186 | 279 | 216 | 324 | 240 | 360 | 270 | 405 | 309 | 463 |
| 10.0 | 162 | 243 | 182 | 273 | 207 | 310 | 240 | 360 | 267 | 400 | 300 | 450 | 343 | 514 |
| 11.0 | 178 | 268 | 200 | 300 | 228 | 341 | 264 | 396 | 293 | 440 | 330 | 495 | 377 | 566 |
| 12.0 | 195 | 292 | 218 | 327 | 248 | 372 | 288 | 432 | 320 | 480 | 360 | 540 | 411 | 617 |

Note: (1) Two-lane – 12 ft 2% cross slope
 (2) Multilane – 12 ft each direction rotated separately

- AASHTO Lengths and Tangent Runouts for Spiral Curves:** AASHTO recommends that when spiral curves are used in transition design, the superelevation runoff should be achieved over the length of the spiral curve. Based on this, it is recommended that the length of the spiral curve should be the length of the superelevation runoff. The runout spiral length and runout length are very different as values of e increase beyond 2 percent. Recommended lengths for tangent runout are shown in Table 3.6. Since it is desirable to maintain runoff within the spiral curve, its length should be increased to that of the runoff value shown in Table 3.5. The change in cross slope begins by introducing a tangent runout section just in advance of the spiral curve.

Table 3.6 Tangent Runout Length L_t for Spiral Curve Transition Design

| Metric | | | | | | U.S. Customary | | | | | |
|---------------------|---------------------------|----|----|----|----|--------------------|----------------------------|-----|----|----|----|
| Design Speed (km/h) | Tangent Runout Length (m) | | | | | Design Speed (mph) | Tangent Runout Length (ft) | | | | |
| | Superelevation Rate | | | | | | Superelevation Rate | | | | |
| | 2 | 4 | 6 | 8 | 10 | | 2 | 4 | 6 | 8 | 10 |
| 20 | 11 | — | — | — | — | 15 | 44 | — | — | — | — |
| 30 | 17 | 8 | — | — | — | 20 | 59 | 30 | — | — | — |
| 40 | 22 | 11 | 7 | — | — | 25 | 74 | 37 | 25 | — | — |
| 50 | 28 | 14 | 9 | — | — | 30 | 88 | 44 | 29 | — | — |
| 60 | 33 | 17 | 11 | 8 | — | 35 | 103 | 52 | 34 | 26 | — |
| 70 | 39 | 19 | 13 | 10 | — | 40 | 117 | 59 | 39 | 29 | — |
| 80 | 44 | 22 | 15 | 11 | — | 45 | 132 | 66 | 44 | 33 | — |
| 90 | 50 | 25 | 17 | 13 | 10 | 50 | 147 | 74 | 49 | 37 | — |
| 100 | 56 | 28 | 19 | 14 | 11 | 55 | 161 | 81 | 54 | 40 | — |
| 110 | 61 | 31 | 20 | 15 | 12 | 60 | 176 | 88 | 59 | 44 | — |
| 120 | 67 | 33 | 22 | 17 | 13 | 65 | 191 | 96 | 64 | 48 | 38 |
| 130 | 72 | 36 | 24 | 18 | 14 | 70 | 205 | 103 | 68 | 51 | 41 |
| | | | | | | 75 | 220 | 110 | 73 | 55 | 44 |
| | | | | | | 80 | 235 | 118 | 78 | 59 | 47 |

Note: (1) Values for $e = 2\%$ represent the desirable lengths of the spiral curve transition.
 (2) Values shown for tangent runout should also be used as the minimum length of the spiral transition curve.

- Attainment of Superelevation:** It is essential that the change from a crowned cross-section to a superelevated one be achieved without causing any discomfort to motorists or creating unsafe conditions. One of four methods can be used to achieve this change on undivided highways:
 - A crowned pavement is rotated about the profile of the centerline.
 - A crowned pavement is rotated about the profile of the inside edge.
 - A crowned pavement is rotated about the profile of the outside edge.
 - A straight cross-slope pavement is rotated about the profile of the outside edge.

Figure 3.17a is a schematic of Method 1. This is the most commonly used method since the distortion obtained is less than that obtained with other methods. The procedure used is first to raise the outside edge of the pavement relative to the centerline, until the outer half of the cross section is horizontal (point B). The outer edge is then raised by an additional amount to obtain a straight cross section. Note that the inside edge is still at its original elevation, as indicated at point C. The whole cross section is then rotated as a unit about the centerline profile until the full superelevation is achieved at point E.

Figure 3.17(b) illustrates Method 2 where the centerline profile is raised with respect to the inside pavement edge to obtain half the required change, while the remaining half is achieved by raising the outside pavement edge with respect to the profile of the centerline.

Method 3, demonstrated by Figure 3.17(c), is similar to Method 2 with the only difference being a change effected below the outside edge profile.

Figure 3.17(d) illustrates Method 4, which is used for sections of straight cross slopes.

Straight lines have been conveniently used to illustrate the different methods, but in practice, the angular breaks are appropriately rounded by using short vertical curves, as shown in Figure 3.17(e).

Superelevation is achieved on divided highways by using one of three methods:

- Method 1: involves superelevating the whole cross section, including the median, as a plane section. The rotation in most cases is done about the centerline of the median. This method is used only for highways with narrow medians and moderate superelevation rates, since large differences in elevation can occur between the extreme pavement edges if the median is wide.
- Method 2: involves rotating each pavement separately around the median edges, while keeping the median in a horizontal plane. This method is used mainly for pavements with median widths of 30 ft or less, although it can be used for any median, because by keeping the median in the horizontal plane, the difference in elevation between the extreme pavement edges does not exceed the pavement superelevation.
- Method 3: treats the two pavements separately, resulting in variable elevation differences between the median edges. This method generally is used on pavements with median widths of 40 ft or greater. The large difference in elevation between the extreme pavement edges is avoided by providing a compensatory slope across the median.

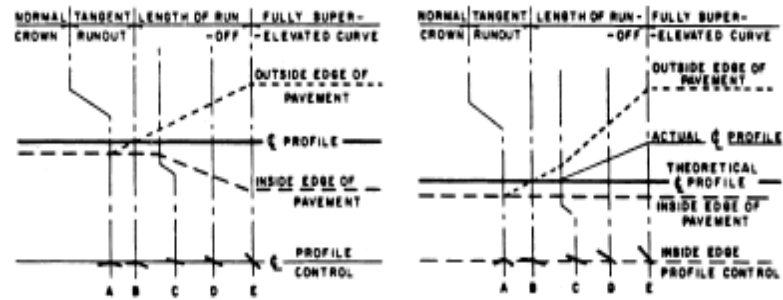

(a) Crowned pavement revolved about centerline (b) Crowned pavement revolved about inside edge

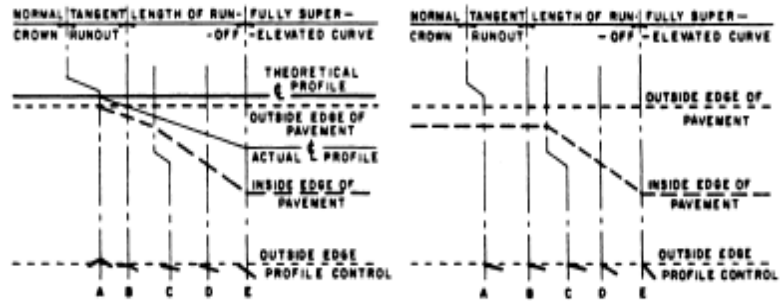

(c) Crowned pavement revolved about outside edge (d) Straight cross slope pavement revolved about outside edge

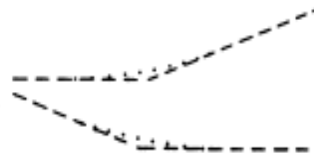

(e) Angular breaks appropriately rounded (dotted lines)

Figure 3.17 Diagrammatic Profiles Showing Methods of Attaining Superelevation for a Curve to the Right

4) Section 4 — Vertical Alignment

The vertical alignment of a highway consists of straight sections known as grades, (or tangents) connected by vertical curves. The design of the vertical alignment therefore involves the selection of suitable grades for the tangent sections and the appropriate length of vertical curves. The topography of the area through which the road traverses has a significant impact on the design of the vertical alignment.

Vertical curves are used to provide a gradual change from one tangent grade to another so that vehicles may run smoothly as they traverse the highway. These curves are usually parabolic in shape. The expressions developed for minimum lengths of vertical curves are therefore based on the properties of a parabola. Figure 4.1 illustrates vertical curves that are classified as crest or sag.

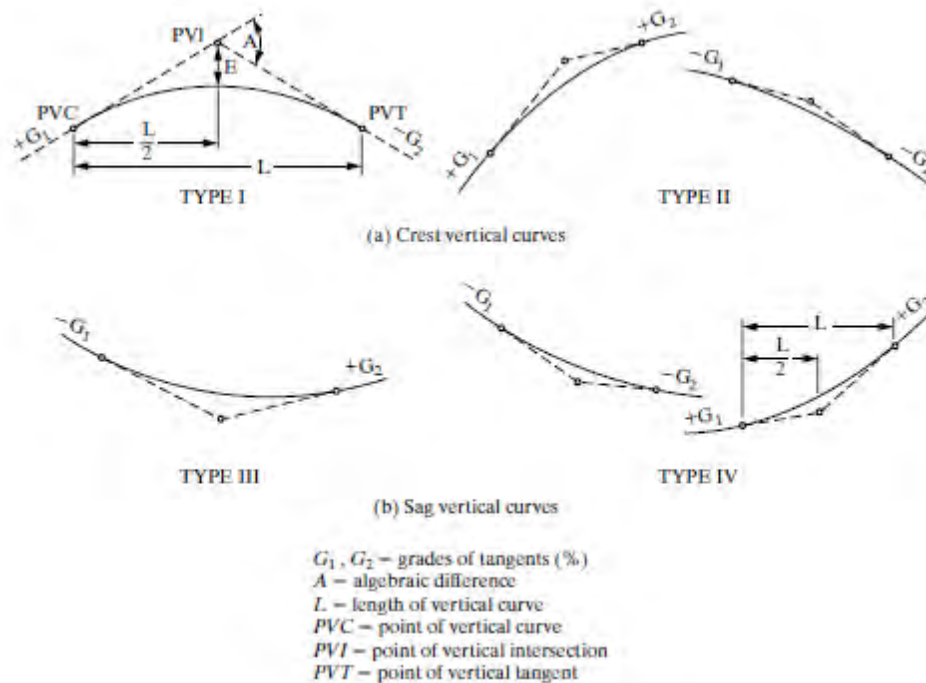

Figure 4.1 Types of Vertical Curves

Terrain

The topography of the land traversed has an influence on the alignment of roads and streets. Topography affects horizontal alignment, but has an even more pronounced effect on vertical alignment. To characterize variations in topography, engineers

generally separate it into three classifications according to terrain level, rolling, and mountainous.

In level terrain, highway sight distances, as governed by both horizontal and vertical restrictions, are generally long or can be made to be so without construction difficulty or major expense.

In rolling terrain, natural slopes consistently rise above and fall below the road or street grade, and occasional steep slopes offer some restriction to normal horizontal and vertical roadway alignment.

In mountainous terrain, longitudinal and transverse changes in the elevation of the ground with respect to the road or street are abrupt, and benching and side hill excavation are frequently needed to obtain acceptable horizontal and vertical alignment.

Terrain classifications pertain to the general character of a specific route corridor. Routes in valleys, passes, or mountainous areas that have all the characteristics of roads or streets traversing level or rolling terrain should be classified as level or rolling. In general, rolling terrain generates steeper grades than level terrain, causing trucks to reduce speeds below those of passenger cars; mountainous terrain has even greater effects, causing some trucks to operate at crawl speeds.

Maximum Highway Grades

The selection of maximum grades for a highway depends on the design speed and the design vehicle. It is generally accepted that grades of 4 to 5 percent have little or no effect on passenger cars, except for those with high weight /horsepower ratios, such as those found in compact and subcompact cars. As the grade increases above 5 percent, however, speeds of passenger cars decrease on upgrades and increase on downgrades.

Grade has a greater impact on trucks than on passenger cars. Extensive studies have been conducted, and results have shown that truck speed may increase up to 5 percent on downgrades and decrease by 7 percent on upgrades, depending on the percent and length of the grade. The impact of grades on recreational vehicles is more significant than that for passenger cars, but it is not as critical as that for trucks; however, it is very difficult to establish maximum grades for recreational routes, and it may be necessary to provide climbing lanes on steep grades when the percentage of recreational vehicles is high.

Maximum grades have been established based on the operating characteristics of the design vehicle on the highway. These vary from 5 percent for a design speed of 70 mi/h to between 7 and 12 percent for a design speed of 30 mi/h, depending on the type of highway.

Minimum grades depend on the drainage conditions of the highway. Zero percent grades may be used on uncurbed pavements with adequate cross slopes to laterally drain the surface water. When pavements are curbed, however, a longitudinal grade should be provided to facilitate the longitudinal flow of the surface water. It is customary to use a minimum of 0.5 percent in such cases, although this may be reduced to 0.3 percent on high-type pavement constructed on suitably crowned, firm ground.

Tables 4.1, 4.2, 4.3, 4.4, 4.5, and 4.6 give recommended values of maximum grades. Note that these recommended maximum grades should not be used frequently, particularly when grades are long and the traffic includes a high percentage of trucks. On the other hand, when grade lengths are less than 500 ft and roads are one-way in the downgrade direction, maximum grades may be increased by up to 2 percent, particularly on low-volume rural highways.

Table 4.1 Maximum Grades for Rural Local Roads

| Type of Terrain | Metric | | | | | | | | | U.S. Customary | | | | | | | | |
|-----------------|---|----|----|----|----|----|----|----|-----|--|----|----|----|----|----|----|----|----|
| | Maximum Grade (%) for Specified Design Speed (km/h) | | | | | | | | | Maximum Grade (%) for Specified Design Speed (mph) | | | | | | | | |
| | 20 | 30 | 40 | 50 | 60 | 70 | 80 | 90 | 100 | 15 | 20 | 25 | 30 | 40 | 45 | 50 | 55 | 60 |
| Level | 9 | 8 | 7 | 7 | 7 | 7 | 6 | 6 | 5 | 9 | 8 | 7 | 7 | 7 | 7 | 6 | 6 | 5 |
| Rolling | 12 | 11 | 11 | 10 | 10 | 9 | 8 | 7 | 6 | 12 | 11 | 11 | 10 | 10 | 9 | 8 | 7 | 6 |
| Mountainous | 17 | 16 | 15 | 14 | 13 | 12 | 10 | 10 | — | 17 | 16 | 15 | 14 | 13 | 12 | 10 | 10 | — |

Concerning grades for urban local roads, grades for local residential streets should be as level as practical, consistent with the surrounding terrain. Grades for local residential streets should be less than 15 percent. Where grades of 4 percent or steeper are necessary, the drainage design may become critical. On such grades, special care should be taken to prevent erosion on slopes and open drainage facilities. Streets in commercial and industrial areas should have grades less than 8 percent, and flatter grades should be encouraged. To provide for proper drainage, the desirable minimum grade for streets with outer curbs should be 0.30 percent, but a minimum grade of 0.20 percent may be used.

Table 4.2 Maximum Grades for Rural Collectors

| Type of Terrain | Metric | | | | | | | | U.S. Customary | | | | | | | | |
|-----------------|---|----|----|----|----|----|----|-----|--|----|----|----|----|----|----|----|----|
| | Maximum Grade (%) for Specified Design Speed (km/h) | | | | | | | | Maximum Grade (%) for Specified Design Speed (mph) | | | | | | | | |
| | 30 | 40 | 50 | 60 | 70 | 80 | 90 | 100 | 20 | 25 | 30 | 35 | 40 | 45 | 50 | 55 | 60 |
| Level | 7 | 7 | 7 | 7 | 7 | 6 | 6 | 5 | 7 | 7 | 7 | 7 | 7 | 7 | 6 | 6 | 5 |
| Rolling | 10 | 10 | 9 | 8 | 8 | 7 | 7 | 6 | 10 | 10 | 9 | 9 | 8 | 8 | 7 | 7 | 6 |
| Mountainous | 12 | 11 | 10 | 10 | 10 | 9 | 9 | 8 | 12 | 11 | 10 | 10 | 10 | 10 | 9 | 9 | 8 |

Note: Short lengths of grade in rural areas, such as grades less than 150 m [500 ft] in length, one-way down-grades, and grades on low-volume rural collectors may be up to 2 percent steeper than the grades shown above.

Table 4.3 Maximum Grades for Urban Collectors

| Type of Terrain | Metric | | | | | | | | U.S. Customary | | | | | | | | |
|-----------------|---|----|----|----|----|----|----|-----|--|----|----|----|----|----|----|----|----|
| | Maximum Grade (%) for Specified Design Speed (km/h) | | | | | | | | Maximum Grade (%) for Specified Design Speed (mph) | | | | | | | | |
| | 30 | 40 | 50 | 60 | 70 | 80 | 90 | 100 | 20 | 25 | 30 | 35 | 40 | 45 | 50 | 55 | 60 |
| Level | 9 | 9 | 9 | 9 | 8 | 7 | 7 | 6 | 9 | 9 | 9 | 9 | 9 | 8 | 7 | 7 | 6 |
| Rolling | 12 | 12 | 11 | 10 | 9 | 8 | 8 | 7 | 12 | 12 | 11 | 10 | 10 | 9 | 8 | 8 | 7 |
| Mountainous | 14 | 13 | 12 | 12 | 11 | 10 | 10 | 9 | 14 | 13 | 12 | 12 | 12 | 11 | 10 | 10 | 9 |

Note: Short lengths of grade in urban areas, such as grades less than 150 m [500 ft] in length, one-way down-grades, and grades on low-volume urban collectors may be up to 2% steeper than the grades shown above.

Table 4.4 Maximum Grades for Rural Arterials

| Type of Terrain | Metric | | | | | | | | U.S. Customary | | | | | | | | |
|-----------------|---|----|----|----|-----|-----|-----|-----|--|----|----|----|----|----|----|----|----|
| | Maximum Grade (%) for Specified Design Speed (km/h) | | | | | | | | Maximum Grade (%) for Specified Design Speed (mph) | | | | | | | | |
| | 60 | 70 | 80 | 90 | 100 | 110 | 120 | 130 | 40 | 45 | 50 | 55 | 60 | 65 | 70 | 75 | 80 |
| Level | 5 | 5 | 4 | 4 | 3 | 3 | 3 | 3 | 5 | 5 | 4 | 4 | 3 | 3 | 3 | 3 | 3 |
| Rolling | 6 | 6 | 5 | 5 | 4 | 4 | 4 | 4 | 6 | 6 | 5 | 5 | 4 | 4 | 4 | 4 | 4 |
| Mountainous | 8 | 7 | 7 | 6 | 6 | 5 | 5 | 5 | 8 | 7 | 7 | 6 | 6 | 5 | 5 | 5 | 5 |

Table 4.5 Maximum Grades for Urban Arterials

| Type of Terrain | Metric | | | | | | U.S. Customary | | | | | | |
|-----------------|---|----|----|----|----|-----|--|----|----|----|----|----|----|
| | Maximum Grade (%) for Specified Design Speed (km/h) | | | | | | Maximum Grade (%) for Specified Design Speed (mph) | | | | | | |
| | 50 | 60 | 70 | 80 | 90 | 100 | 30 | 35 | 40 | 45 | 50 | 55 | 60 |
| Level | 8 | 7 | 6 | 6 | 5 | 5 | 8 | 7 | 7 | 6 | 6 | 5 | 5 |
| Rolling | 9 | 8 | 7 | 7 | 6 | 6 | 9 | 8 | 8 | 7 | 7 | 6 | 6 |
| Mountainous | 11 | 10 | 9 | 9 | 8 | 8 | 11 | 10 | 10 | 9 | 9 | 8 | 8 |

Table 4.6 Maximum Grades for Rural and Urban Freeways

| Type of Terrain | Metric | | | | | | U.S. Customary | | | | | | | |
|-----------------|-------------------------|----|-----|-----|-----|-----|-------------------------|----|----|----|----|----|----|--|
| | Design Speeds (km/h) | | | | | | Design Speeds (mph) | | | | | | | |
| | 80 | 90 | 100 | 110 | 120 | 130 | 50 | 55 | 60 | 65 | 70 | 75 | 80 | |
| | Grades (%) ^a | | | | | | Grades (%) ^a | | | | | | | |
| Level | 4 | 4 | 3 | 3 | 3 | 3 | 4 | 4 | 3 | 3 | 3 | 3 | 3 | |
| Rolling | 5 | 5 | 4 | 4 | 4 | 4 | 5 | 5 | 4 | 4 | 4 | 4 | 4 | |
| Mountainous | 6 | 6 | 6 | 5 | — | — | 6 | 6 | 6 | 5 | 5 | — | — | |

^a Grades 1% steeper than the value shown may be provided in urban areas with right-of-way constraints or where needed in mountainous terrain.

Length of Crest Vertical Curves

Minimum lengths of crest vertical curves based on sight distance criteria generally are satisfactory from the standpoint of safety, comfort, and appearance. An exception may be at decision areas, such as ramp exit gores, where longer sight distances and, therefore, longer vertical curves should be provided. Figures 4.2 and 4.3 illustrate the parameters used in determining the length of a parabolic crest vertical curve needed to provide any specified value of stopping sight distance or passing sight distance.

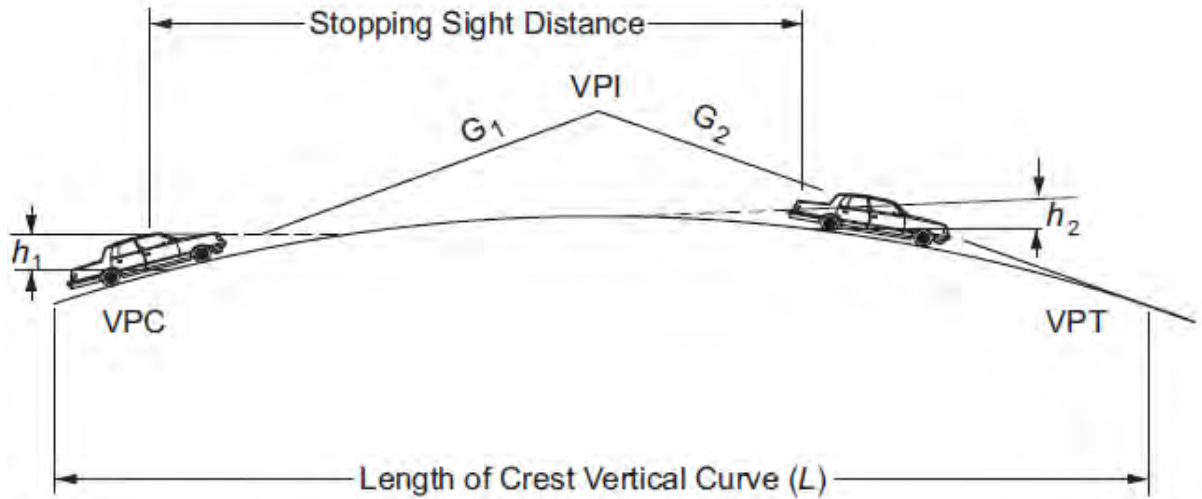

Figure 4.2 Parameters Considered in Determining the Length of a Crest Vertical Based on Stopping Sight Distance

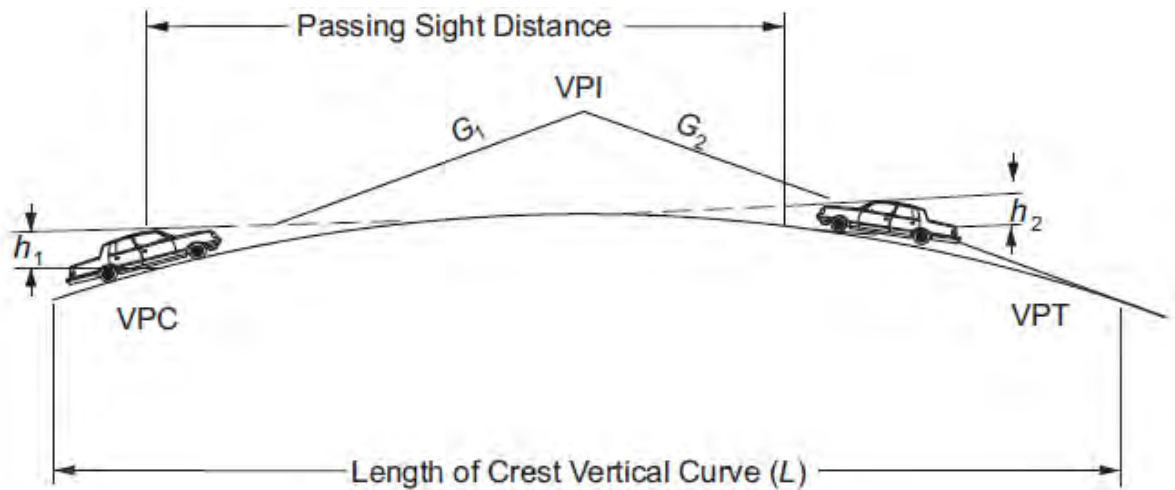

Figure 4.3 Parameters Considered in Determining the Length of a Crest Vertical Based on Passing Sight Distance

The basic equations for length of a crest vertical curve in terms of algebraic difference in grade and sight distance are presented in Table 4.7. Table 4.8 shows the basic equations for L_{min} for crest vertical curves based on stopping sight distance

substituting the height of eye and the height of object with 1.08 and 0.60 m [3.50 ft and 2.00 ft], respectively.

- **Design Controls, Stopping Sight Distance:** Table 4.9 shows the computed K values for lengths of vertical curves corresponding to the stopping sight distances. The values of K derived above when S is less than L also can be used without significant error where S is greater than L. As shown in Figure 4.2, extension of the diagonal lines to meet the vertical lines for minimum lengths of vertical curves results in appreciable differences from the theoretical only where A is small and little or no additional cost is involved in obtaining longer vertical curves.
- **Design Controls, Passing Sight Distance:** Design values of crest vertical curves for passing sight distance differ from those for stopping sight distance because of the different sight distance and object height criteria. The general equations in Table 4.7 apply. Using the 1.08-m [3.50-ft] height of object results in the following specific formulas as shown in Table 4.10 with the same terms as shown in Table 4.7. For the minimum passing sight distances, the minimum lengths of crest vertical curves are substantially longer than those for stopping sight distances. The extent of difference is evident by the values of K, or length of vertical curve per percent change in A, for passing sight distances shown in Table 4.11.

Table 4.7 Basic Equations for L_{min} for Crest Vertical Curves

| Metric | U.S. Customary |
|---|---|
| When S is less than L , | When S is less than L , |
| $L = \frac{AS^2}{100(\sqrt{2h_1} + \sqrt{2h_2})^2}$ | $L = \frac{AS^2}{100(\sqrt{2h_1} + \sqrt{2h_2})^2}$ |
| When S is greater than L , | When S is greater than L , |
| $L = 2S - \frac{200(\sqrt{h_1} + \sqrt{h_2})^2}{A}$ | $L = 2S - \frac{200(\sqrt{h_1} + \sqrt{h_2})^2}{A}$ |
| where: | where: |
| L = length of vertical curve, m | L = length of vertical curve, ft |
| A = algebraic difference in grades, percent | A = algebraic difference in grades, percent |
| S = sight distance, m | S = sight distance, ft |
| h_1 = height of eye above roadway surface, m | h_1 = height of eye above roadway surface, ft |
| h_2 = height of object above roadway surface, m | h_2 = height of object above roadway surface, ft |

Table 4.8 Basic Equations for L_{min} for Crest Vertical Curves Based on Stopping Sight Distance

| Metric | U.S. Customary |
|--------------------------------|--------------------------------|
| When S is less than L , | When S is less than L , |
| $L = \frac{AS^2}{658}$ | $L = \frac{AS^2}{2158}$ |
| When S is greater than L , | When S is greater than L , |
| $L = 2S - \frac{658}{A}$ | $L = 2S - \frac{2158}{A}$ |

Table 4.9 Design Controls for Crest Vertical Curves Based on Stopping Sight Distance

| Metric | | | | U.S. Customary | | | |
|---------------------|-----------------------------|-----------------------------------|--------|--------------------|------------------------------|-----------------------------------|--------|
| Design Speed (km/h) | Stopping Sight Distance (m) | Rate of Vertical Curvature, K^a | | Design Speed (mph) | Stopping Sight Distance (ft) | Rate of Vertical Curvature, K^a | |
| | | Calculated | Design | | | Calculated | Design |
| 20 | 20 | 0.6 | 1 | 15 | 80 | 3.0 | 3 |
| 30 | 35 | 1.9 | 2 | 20 | 115 | 6.1 | 7 |
| 40 | 50 | 3.8 | 4 | 25 | 155 | 11.1 | 12 |
| 50 | 65 | 6.4 | 7 | 30 | 200 | 18.5 | 19 |
| 60 | 85 | 11.0 | 11 | 35 | 250 | 29.0 | 29 |
| 70 | 105 | 16.8 | 17 | 40 | 305 | 43.1 | 44 |
| 80 | 130 | 25.7 | 26 | 45 | 360 | 60.1 | 61 |
| 90 | 160 | 38.9 | 39 | 50 | 425 | 83.7 | 84 |
| 100 | 185 | 52.0 | 52 | 55 | 495 | 113.5 | 114 |
| 110 | 220 | 73.6 | 74 | 60 | 570 | 150.6 | 151 |
| 120 | 250 | 95.0 | 95 | 65 | 645 | 192.8 | 193 |
| 130 | 285 | 123.4 | 124 | 70 | 730 | 246.9 | 247 |
| | | | | 75 | 820 | 311.6 | 312 |
| | | | | 80 | 910 | 383.7 | 384 |

^a Rate of vertical curvature, K , is the length of curve per percent algebraic difference in intersecting grades (A), $K = L/A$.

Table 4.10 Basic Equations for L_{min} for Crest Vertical Curves Based on Passing Sight Distance

| Metric | U.S. Customary |
|--------------------------------|--------------------------------|
| When S is less than L , | When S is less than L , |
| $L = \frac{AS^2}{864}$ | $L = \frac{AS^2}{2800}$ |
| When S is greater than L , | When S is greater than L , |
| $L = 2S - \frac{864}{A}$ | $L = 2S - \frac{2800}{A}$ |

Table 4.11 Design Controls for Crest Vertical Curves Based on Passing Sight Distance

| Metric | | | U.S. Customary | | |
|---------------------|----------------------------|--|--------------------|-----------------------------|--|
| Design Speed (km/h) | Passing Sight Distance (m) | Rate of Vertical Curvature, K^a Design | Design Speed (mph) | Passing Sight Distance (ft) | Rate of Vertical Curvature, K^a Design |
| 30 | 120 | 17 | 20 | 400 | 57 |
| 40 | 140 | 23 | 25 | 450 | 72 |
| 50 | 160 | 30 | 30 | 500 | 89 |
| 60 | 180 | 38 | 35 | 550 | 108 |
| 70 | 210 | 51 | 40 | 600 | 129 |
| 80 | 245 | 69 | 45 | 700 | 175 |
| 90 | 280 | 91 | 50 | 800 | 229 |
| 100 | 320 | 119 | 55 | 900 | 289 |
| 110 | 355 | 146 | 60 | 1000 | 357 |
| 120 | 395 | 181 | 65 | 1100 | 432 |
| 130 | 440 | 224 | 70 | 1200 | 514 |
| | | | 75 | 1300 | 604 |
| | | | 80 | 1400 | 700 |

^a Rate of vertical curvature, K , is the length of curve per percent algebraic difference in intersecting grades (A), $K = L/A$.

Generally, it is impractical to design crest vertical curves that provide passing sight distance because of high cost where crest cuts are involved and the difficulty of fitting the resulting long vertical curves to the terrain, particularly for high-speed roads. Passing sight distance on crest vertical curves may be practical on roads with unusual combinations of low design speeds and gentle grades or higher design speeds with very small algebraic differences in grades. Ordinarily, passing sight distance is provided only at locations where combinations of alignment and profile do not need significant grading.

Length of Sag Vertical Curves

At least four different criteria for establishing lengths of sag vertical curves are recognized to some extent. These are (1) headlight sight distance, (2) passenger comfort, (3) drainage control, and (4) general appearance. The largest value shall be used as the minimum length of sag vertical curves.

Headlight sight distance has been used directly by some agencies and for the most part is the basis for determining the length of sag vertical curves recommended here. When a vehicle traverses a sag vertical curve at night, the portion of highway lighted

ahead is dependent on the position of the headlights and the direction of the light beam. A headlight height of 0.60 m [2 ft] and a 1-degree upward divergence of the light beam from the longitudinal axis of the vehicle is commonly assumed. The upward spread of the light beam above the 1-degree divergence angle provides some additional visible length of roadway, but is not generally considered in design. Table 4.12 shows the equations relating S, L, and A, using S as the distance between the vehicle and the point where the 1-degree upward angle of the light beam intersects the surface of the roadway. For drivers to see the roadway ahead, a sag vertical curve should be long enough that the light beam distance is approximately the same as the stopping sight distance. Accordingly, it is appropriate to use stopping sight distances for different design speeds as the value of S as specified in Table 4.12.

Table 4.12 Basic Equations for L_{min} for Sag Vertical Curves

| Metric | U.S. Customary |
|---|---|
| When S is less than L , | When S is less than L , |
| $L = \frac{AS^2}{200[0.6 + S(\tan 1^\circ)]}$ | $L = \frac{AS^2}{200[2.0 + S(\tan 1^\circ)]}$ |
| or, | or, |
| $L = \frac{AS^2}{120 + 3.5S}$ | $L = \frac{AS^2}{400 + 3.5S}$ |
| When S is greater than L , | When S is greater than L , |
| $L = 2S - \frac{200[0.6 + S(\tan 1^\circ)]}{A}$ | $L = 2S - \frac{200[2.0 + S(\tan 1^\circ)]}{A}$ |
| or, | or, |
| $L = 2S - \frac{120 + 3.5S}{A}$ | $L = 2S - \frac{400 + 3.5S}{A}$ |
| where: | where: |
| L = length of sag vertical curve, m | L = length of sag vertical curve, ft |
| A = algebraic difference in grades, percent | A = algebraic difference in grades, percent |
| S = light beam distance, m | S = light beam distance, ft |

The effect on passenger comfort of the change in vertical direction is greater on sag than on crest vertical curves because gravitational and centripetal forces are combining rather than opposing forces. Comfort due to change in vertical direction is not easily measured because it is affected appreciably by vehicle body suspension, vehicle body weight, tire flexibility, and other factors. Limited attempts at such measurements have led to the broad conclusion that riding is comfortable on sag vertical curves when the centripetal acceleration does not exceed 0.3 m/s^2 [1 ft/s^2]. The general expression for such a criterion is shown in Table 4.13.

Table 4.13 Basic Equations for L_{min} for Sag Vertical Curves Based on Comfort

| Metric | U.S. Customary |
|--|--|
| $L = \frac{AV^2}{395}$ | $L = \frac{AV^2}{46.5}$ |
| where: L = length of sag vertical curve, m A = algebraic difference in grades, percent V = design speed, km/h | where: L = length of sag vertical curve, ft A = algebraic difference in grades, percent V = design speed, mph |

Drainage affects design of vertical curves of Type III (see Figure 4.1) where curbed sections are used. An approximate criterion for sag vertical curves is the same as that expressed for the crest conditions (i.e., a minimum grade of 0.30 percent should be provided within 15 m [50 ft] of the level point). This criterion corresponds to K of 51 m [167 ft] per percent change in grade, as the drainage maximum. The length of the vertical curve based on drainage is KA . The drainage criterion differs from other criteria in that the length of sag vertical curve determined for it is a maximum, whereas, the length for any other criterion is a minimum. The maximum length of the drainage criterion is greater than the minimum length for other criteria up to 100 km/h [65 mph].

For improved appearance of sag vertical curves, previous guidance used a rule-of-thumb for minimum curve length of $30A$ [$100A$] or, $K = 30 \text{ m}$ [$K = 100 \text{ ft}$] per percent change in grade. This approximation is a generalized control for small or intermediate values of A . The length of the vertical curve based on appearance is KA . Compared with headlight sight distance, it corresponds to a design speed of

approximately 80 km/h [50 mph]. On high-type highways, longer curves are appropriate to improve appearance.

Again, the length of sag vertical curves shall be calculated based on headlight sight distance, comfort, drainage for Type III, and appearance and the largest length shall be used as the length of the sag vertical curve.

From the preceding discussion, it is evident that design controls for sag vertical curves differ from those for crests, and separate design values are needed. The headlight sight distance appears to be the most logical criterion for general use, and the values determined for stopping sight distances are within the limits recognized in current practice. The use of this criterion to establish design values for a range of lengths of sag vertical curves is recommended. As in the case of crest vertical curves, it is convenient to express the design control in terms of the K rate for all values of A. This entails some deviation from the computed values of K for small values of A, but the differences are not significant. Table 4.14 shows the range of computed values and the rounded values of K selected as design controls.

Sag vertical curves shorter than the lengths computed from Table 4.14 may be justified for economic reasons in cases where an existing feature, such as a structure not ready for replacement, controls the vertical profile. In certain cases, ramps may also be designed with shorter sag vertical curves. Fixed-source lighting is desirable in such cases. For street design, some engineers accept design of a sag or crest where A is about 1 percent or less without a length of calculated vertical curve; however, field modifications during construction usually result in constructing the equivalent to a vertical curve, even if short.

Table 4.14 Design Controls for Sag Vertical Curves Based on Stopping Sight Distance

| Metric | | | | U.S. Customary | | | |
|---------------------|-----------------------------|-----------------------------------|--------|--------------------|------------------------------|-----------------------------------|--------|
| Design Speed (km/h) | Stopping Sight Distance (m) | Rate of Vertical Curvature, K^a | | Design Speed (mph) | Stopping Sight Distance (ft) | Rate of Vertical Curvature, K^a | |
| | | Calculated | Design | | | Calculated | Design |
| 20 | 20 | 2.1 | 3 | 15 | 80 | 9.4 | 10 |
| 30 | 35 | 5.1 | 6 | 20 | 115 | 16.5 | 17 |
| 40 | 50 | 8.5 | 9 | 25 | 155 | 25.5 | 26 |
| 50 | 65 | 12.2 | 13 | 30 | 200 | 36.4 | 37 |
| 60 | 85 | 17.3 | 18 | 35 | 250 | 49.0 | 49 |
| 70 | 105 | 22.6 | 23 | 40 | 305 | 63.4 | 64 |
| 80 | 130 | 29.4 | 30 | 45 | 360 | 78.1 | 79 |
| 90 | 160 | 37.6 | 38 | 50 | 425 | 95.7 | 96 |
| 100 | 185 | 44.6 | 45 | 55 | 495 | 114.9 | 115 |
| 110 | 220 | 54.4 | 55 | 60 | 570 | 135.7 | 136 |
| 120 | 250 | 62.8 | 63 | 65 | 645 | 156.5 | 157 |
| 130 | 285 | 72.7 | 73 | 70 | 730 | 180.3 | 181 |
| | | | | 75 | 820 | 205.6 | 206 |
| | | | | 80 | 910 | 231.0 | 231 |

^a Rate of vertical curvature, K , is the length of curve (m) per percent algebraic difference intersecting grades (A), $K = L/A$.

- Length of Sag Vertical Curves at Under-Crossing:** Sight distance through a grade crossing needs to be as long as the minimum stopping sight distance and preferably longer. Line of sight may cut by the structure and limit the sight distance to less than otherwise is attainable. Where practical, provide the minimum length of sag vertical curve at grade separated structures as shown in Figure 4.4, where the VPC (or PVC) and VPT (or PVT) are the vertical point of curve and vertical point of tangent, respectively.

Sag curves at under-crossings should be designed to provide vertical clearance for the largest legal vehicle that could use the under-crossing without a permit. For example, a WB-67 tractor-trailer will need a longer sag curve than a single-unit truck to avoid striking the overhead structure.

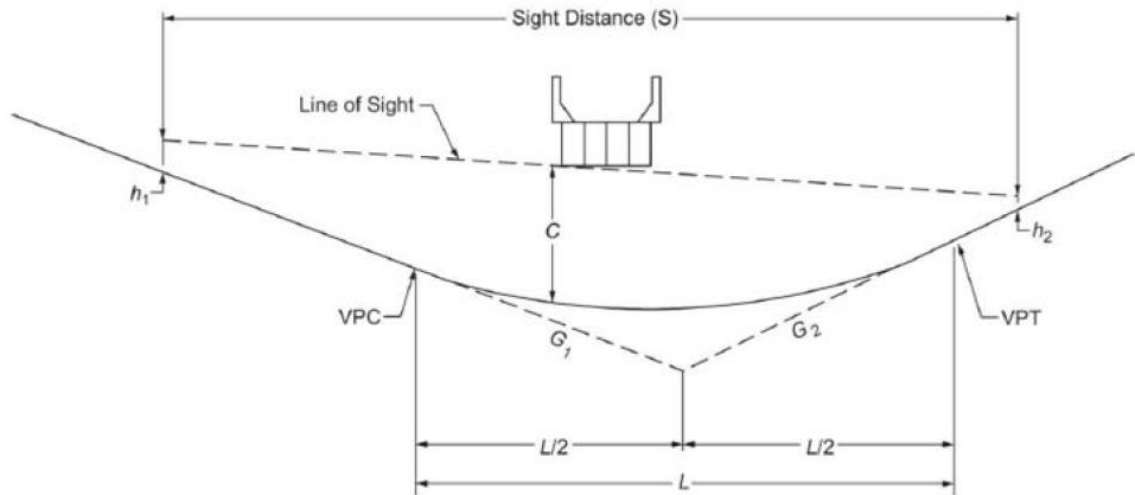

Figure 4.4 Sight Distance at Under-Crossings

The general equations for sag vertical curve length at under-crossings are shown in Tables 4.15 and 4.16.

Table 4.15 Case 1: Sight Distance Greater than Length of Vertical Curve ($S > L$)

| Metric | U.S. Customary |
|---|--|
| $L = 2S - \frac{800 \left[C - \left(\frac{h_1 + h_2}{2} \right) \right]}{A}$ | $L = 2S - \frac{800 \left[C - \left(\frac{h_1 + h_2}{2} \right) \right]}{A}$ |
| where: L = length of vertical curve, m S = sight distance, m C = vertical clearance, m h_1 = height of eye, m h_2 = height of object, m A = algebraic difference in grades, percent | where: L = length of vertical curve, ft S = sight distance, ft C = vertical clearance, ft h_1 = height of eye, ft h_2 = height of object, ft A = algebraic difference in grades, percent |

Table 4.16 Case 2: Sight Distance Greater than Length of Vertical Curve ($S < L$)

| Metric | U.S. Customary |
|--|--|
| $L = \frac{AS^2}{800 \left[C - \left(\frac{h_1 + h_2}{2} \right) \right]}$ | $L = \frac{AS^2}{800 \left[C - \left(\frac{h_1 + h_2}{2} \right) \right]}$ |
| where: | where: |
| L = length of vertical curve, m | L = length of vertical curve, ft |
| A = algebraic difference in grades, percent | A = algebraic difference in grades, percent |
| S = sight distance, m | S = sight distance, ft |
| C = vertical clearance, m | C = vertical clearance, ft |
| h_1 = height of eye, m | h_1 = height of eye, ft |
| h_2 = height of object, m | h_2 = height of object, ft |

Using an eye height of 2.4 m [8.0 ft] for a truck driver and an object height of 0.6 m [2.0 ft] for the taillights of a vehicle, the following equations are shown in Tables 4.17 and 4.18.

Table 4.17 Case 1: Sight Distance Greater than Length of Vertical Curve ($S > L$)

| Metric | U.S. Customary |
|-----------------------------------|---------------------------------|
| $L = 2S - \frac{800(C - 1.5)}{A}$ | $L = 2S - \frac{800(C - 5)}{A}$ |

Table 4.18 Case 2: Sight Distance Greater than Length of Vertical Curve ($S < L$)

| Metric | U.S. Customary |
|---------------------------------|-------------------------------|
| $L = \frac{AS^2}{800(C - 1.5)}$ | $L = \frac{AS^2}{800(C - 5)}$ |

The general equation for vertical curves (crest and sag) with respect to the PVC, with r being an axis in the horizontal plane and z being the vertical axis, and G_1 the grade that passes through the PVC and G_2 the grade that passes through the PVT, is as follows (refer to Figure 4.5 for the case of a crest vertical curve):

$$z = -(G_1 - G_2)(r^2)/(2L) + G_1r$$

The coordinates of the peak of the curve (crest and sag) are as follows:

$$r_{\text{peak}} = LG_1/(G_1 - G_2)$$

$$z_{\text{peak}} = (LG_1^2)/2(G_1 - G_2)$$

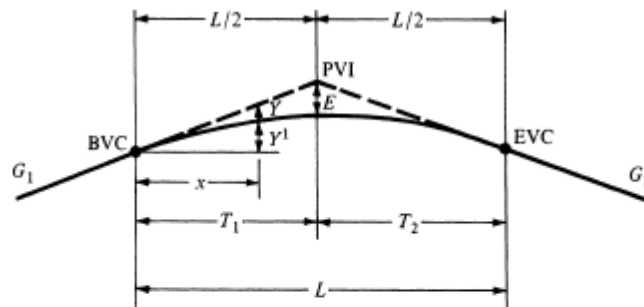

PVI = point of vertical intersection.
 BVC = beginning of vertical curve (same point as PVC)
 EVC = end of vertical curve (same point as PVT)
 E = external distance
 G_1, G_2 = grades of tangents (%)
 L = length of curve
 A = algebraic difference of grades, $G_1 - G_2$

Figure 4.5 Layout of a Crest Vertical Curve for Design

General Controls for Vertical Alignment

In addition to the specific controls for vertical alignment discussed previously, there are several general controls that should be considered in design:

1. A smooth grade line with gradual changes, as consistent with the type of highway, road, or street and the character of terrain, should be sought for in preference to a line with numerous breaks and short lengths of grades. Specific design criteria are the maximum grade and the critical length of grade, but the manner in which they are applied and fitted to the terrain on a continuous line determines the suitability and appearance of the finished product.

2. The “roller-coaster” or the “hidden-dip” type of profile should be avoided. Such profiles generally occur on relatively straight, horizontal alignment where the roadway profile closely follows a rolling natural ground line. Examples of such undesirable profiles are evident on many older roads and streets; they are unpleasant aesthetically and difficult to drive. Hidden dips may create difficulties for drivers who wish to pass, because the passing driver may be deceived if the view of the road or street beyond the dip is free of opposing vehicles. Even with shallow dips, this type of profile may be disconcerting, because the driver cannot be sure whether or not there is an oncoming vehicle hidden beyond the rise. This type of profile is avoided by use of horizontal curves or by more gradual grades.
3. Undulating grade lines, involving substantial lengths of momentum grades, should be evaluated for their effect on traffic operation. Such profiles permit heavy trucks to operate at higher overall speeds than where an upgrade is not preceded by a downgrade, but may encourage excessive speeds of trucks with attendant conflicts with other traffic.
4. A “broken-back” grade line (two vertical curves in the same direction separated by a short section of tangent grade) generally should be avoided, particularly in sags where the full view of both vertical curves is not pleasing. This effect is particularly noticeable on divided roadways with open median sections.
5. On long grades, it may be preferable to place the steepest grades at the bottom and flatten the grades near the top of the ascent or to break the sustained grade by short intervals of flatter grade instead of providing a uniform sustained grade that is only slightly below the recommended maximum. This is particularly applicable to roads and streets with low design speeds.
6. Where at-grade intersections occur on roadway sections with moderate to steep grades, it is desirable to reduce the grade through the intersection. Such profile changes are beneficial for vehicles making turns and serve to reduce the potential for crashes.
7. Sag vertical curves should be avoided in cuts unless adequate drainage can be provided.

Combination of Vertical and Horizontal Alignment

Due to the near permanent nature of roadway alignment once constructed, it is important that the proper selected alignment be consistent with design speed, existing and future roadside

development, subsurface conditions, topography, etc. The following factors are general considerations in obtaining a proper combination of horizontal and vertical alignment:

1. The design speed of both vertical and horizontal alignment should be compatible with longer vertical curves and flatter horizontal curves than dictated by minimum values. Design speed should be compatible with topography with the roadway fitting the terrain where feasible.
2. The alignment should be as flat as possible near intersections where sight distance is important.
3. For rural divided facilities, independent main lane profiles are often more aesthetic and economical. Where used on non-controlled access facilities with narrow medians, care should be exercised in the location of median openings to minimize crossover grades and insure adequate sight distance for vehicles stopped therein.
4. When designing independent vertical and horizontal profiles on divided facilities, considerations should be given to the impact these profiles may have on future widening into the median.
5. For two-lane rural highways and Super 2 Highways, the need for safe passing sections at frequent intervals should be carefully considered in developing horizontal and vertical alignments.

REFERENCES:

A Policy on Geometric Design of Highways and Streets, 7th Edition AASHTO. Washington, D.C. 2018.